

BOSCAROL®

Emergency Medical Systems





INDEX

	PAGE
MEDICAL SUCTION UNIT	6
EMERGENCY BAGS & RUCKSACKS	24
IMMOBILIZATION	42
RESUSCITATOR BAGS	59
DIAGNOSTICS	66
REANIMATION	77
MEDICATION	87
MEDICAL OXYGEN	127
OTHERS, ACCESSORIES, DIDACTICS	133
CONTACTS AND SELLING CONDITIONS	137

Dear Customer,
herewith we inform you that due to our Ministry of Health instructions related to the advertisement of medical devices, diagnostics in vitro and surgical medical devices, the featuring of the pages hereafter are appointed to professionals. We also remind you that our products description only aims to inform and are not intended for promotional purpose.

INTRODUCTION



Oscar Boscarol srl has always encouraged the research for vanguard solutions and technologies with compelling quality that might match the operators needs during emergency activities. This is the force that led our products to become a helping hand, an indispensable support and constant reference for all insiders. Today the Oscar Boscarol srl is a worldwide leader exporting half of its products to foreign markets.





MADE IN ITALY

Our OB medical suction units are entirely manufactured in Italy at our headquarters in Bolzano in order to guarantee care and quality control, starting from the materials used up to the assembly of the device and the control of its correct functioning before customer delivery.

HISTORY-RELIABILITY

We have been manufacturing medical suction units since the 90s and we are at the top of the international competition with over 40,000 units sold worldwide (Europe, Asia, India, South America and Africa).

COMPLIANCE WITH REGULATIONS

All our devices comply with current regulations: our quality system was developed according to the ISO 9001 and ISO 13485 standards and our products are compliant with MDR Regulation 745, by always placing first the need to produce qualitatively impeccable devices that comply with the mandatory requirements.

DIRECTIVES, RULES AND REGULATIONS OF REFERENCE

Current regulatory references our suction units comply with.

MDR 2017/745 European Regulation for Medical Devices

ISO 10079-1 Medical suction equipment - Part 1: electrically powered suction equipment

IEC 60601-1 Medical Electrical Equipment. General requirements for basic safety and essential performance

IEC 60601-1-2 Medical electrical equipment - Part 1-2: General requirements for basic safety and essential performance - Collateral Standard: Electromagnetic disturbances - Requirements and tests

RTCA DO-160G Medical electrical equipment - Part 1-2: General requirements for basic safety and essential performance - Collateral Standard: Electromagnetic disturbances - Requirements and tests
ONLY FOR OUR AVIO SUCTION UNIT MODELS

IEC 60601-1-11 Medical Electrical Equipment General requirements for basic safety and essential performance - Collateral standard: Requirements for medical electrical equipment and medical electrical systems used in the home healthcare environment

IEC 60601-1-12 Medical Electrical Equipment General requirements for basic safety and essential performance - Collateral standard: Requirements for medical electrical equipment and medical electrical systems used in the emergency medical services environment

UNI EN 1789 Medical vehicles and their equipment - Road ambulances

ECE R10 Uniform provisions concerning the approval of vehicles with regard to electromagnetic compatibility



OB 3000

OB 3000

FLOW RATE-MAX VACUUM	33 LPM - 800 mbar (80 kPa)
RATED VOLTAGE	11÷30 Vcc
AUTONOMY	60 minutes ±10%
IP RATING	IP 44
BATTERY TYPE	LIPO 11,1V - 5 Ah removable
WARRANTY	5 years
PERIODIC MAINTENANCE	2 years (automatic reminder)
RTCA DO160G	YES in AVIO version
DIMENSIONS	360x244(h)x110 mm
WEIGHT	2,6 kg with accessories (without wall bracket)



OB 3000

POWERFUL AND RELIABLE

Max. flow rate 33 liter/minute with double piston suction pump and max. vacuum rate 800 mbar. Inner microprocessor records production data and functioning tracing and a safety inspection reminder indicates that the suction unit has to be sent for the scheduled maintenance. Analogic fluorescent vacuum meter, with mmHg scale upon request.



BATTERY AND RECHARGING SYSTEM

Battery can be easily replaced by user and battery status indicator with no need to turn the device on.
Upon request the device can be supplied with a wall bracket (conformed to EN 1789) and with a 2-poles main power supply male connector.

WEIGHT AND DIMENSIONS

FA version: 1000 ml autoclavable canister with protection overflow valve and protection filter directly on the cover.
FM version: 1000 ml OB-J canister suitable for the use of Serres liners.
Extreme lightwightness and reduced dimensions make of this unit an easily portable device.



- BSU3000ST- OB 3000 FA MEDICAL SUCTION UNIT
- BSU3020 - OB 3000 FM MEDICAL SUCTION UNIT
- BSU3000A - OB 3000 AVIO FA MEDICAL SUCTION UNIT
- BSU3020A - OB 3000 AVIO FM MEDICAL SUCTION UNIT



OB MINI

FLOW RATE-MAX VACUUM	25 LPM - 850 mbar (85 kPa)
RATED VOLTAGE	11÷30 Vcc
AUTONOMY	60 minutes ±10%
IP RATING	IP 43
BATTERY TYPE	LIPO 11,1V - 5 Ah
WARRANTY	3 years
PERIODIC MAINTENANCE	2 years (automatic reminder)
RTCA DO160G	YES in AVIO version
DIMENSIONS	290×240(h)×95 mm
WEIGHT	1,8 kg with accessories

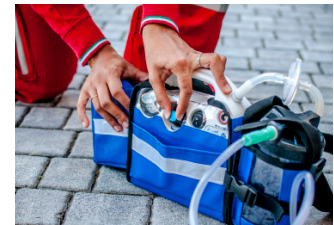

OB MINI

RELIABLE AND ULTRA LIGHTWEIGHT

Max. flow rate 25 liter/minute with double piston suction pump and max. vacuum rate 850 mbar. Inner microprocessor records production data and functioning tracing and a safety inspection reminder indicates that the suction unit has to be sent for the scheduled maintenance. Only 1,8 kg for a device complete with 500cc canister: maximum lightweight and compactness.

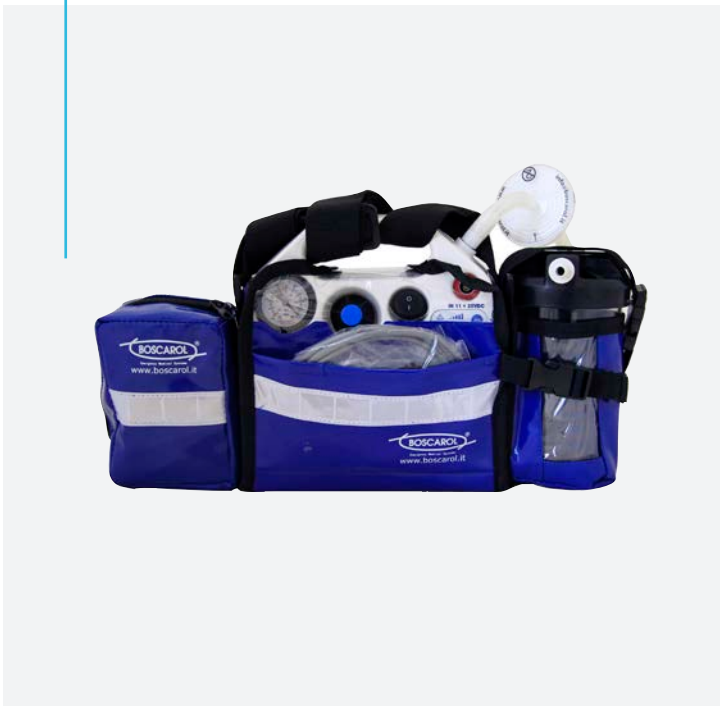

JAR

500 cc autoclavable canister or upon request 1 l FA and 1 l FM version.
FA version: 1000 ml autoclavable canister with protection overflow valve and protection filter directly on the cover.
FM version: 1000 ml OB-J canister



POWER SUPPLY AND BAG

2-poles main power supply
male connector.
Blue transport bag with
lateral poche with velcro.

BSU360EU - OB MINI 500ML MEDICAL SUCTION UNIT EU
BSU360JP - OB MINI 500ML MEDICAL SUCTION UNIT JP/USA
BSU360UK - OB MINI 500ML MEDICAL SUCTION UNIT UK
BSU370 - OB MINI AVIO 500ML MEDICAL SUCTION UNIT EU
BSU370JP - OB MINI AVIO 500ML MEDICAL SUCTION UNIT JP
BSU370UK - OB MINI AVIO 500ML MEDICAL SUCTION UNIT UK
BSU364EU - OB MINI FA MEDICAL SUCTION UNIT EU
BSU364JP - OB MINI FA MEDICAL SUCTION UNIT JP
BSU364UK - OB MINI FA MEDICAL SUCTION UNIT UK
BSU368EU - OB MINI FM MEDICAL SUCTION UNIT EU
BSU368JP - OB MINI FM MEDICAL SUCTION UNIT JP
BSU368UK - OB MINI FM MEDICAL SUCTION UNIT UK
BSU372 - OB MINI AVIO FA MEDICAL SUCTION UNIT EU
BSU372JP - OB MINI AVIO FA MEDICAL SUCTION UNIT JP
BSU372UK - OB MINI AVIO FA MEDICAL SUCTION UNIT UK
BSU374 - OB MINI AVIO FM MEDICAL SUCTION UNIT EU
BSU374JP - OB MINI AVIO FM MEDICAL SUCTION UNIT JP
BSU374UK - OB MINI AVIO FM MEDICAL SUCTION UNIT UK



OB 2012

OB2012

FLOW RATE-MAX VACUUM	30 LPM - 800 mbar (80 kPa)
RATED VOLTAGE	12÷15 Vcc
AUTONOMY	60 minutes ±10%
IP RATING	IP 34d
BATTERY TYPE	SLA 12V - 4 Ah
WARRANTY	3 years
PERIODIC MAINTENANCE	2 years
RTCA DO 160G	NO
DIMENSIONS	350×240(h)×120 mm
WEIGHT	4,6 kg with accessories (without wall bracket)



HARD AND RESISTANT

Max. flow rate 30 liter/minute with double piston suction pump and max. vacuum rate 800 mbar.



FLACONI

FA version: 1000 ml autoclavable canister with protection overflow valve and protection filter directly on the cover.
FM version: 1000 ml OB-J canister suitable for the use of Serres liners.



RECHARGING SYSTEM

Upon request the device can be supplied with a wall bracket (conformed to EN 1789) and with a 2-poles main power supply male connector.
Red transport bag.

BSU150	- OB2012 FA MEDICAL SUCTION UNIT
BSU154	- OB2012 FA MEDICAL SUCTION UNIT + WALL BRACKET
BSU158	- OB2012 FA MEDICAL SUCTION UNIT COMPLETE
BSU100	- OB2012 LINER MEDICAL SUCTION UNIT
BSU104	- OB2012 LINER MEDICAL SUCTION UNIT + WALL BRACKET
BSU108	- OB2012 LINER MEDICAL SUCTION UNIT COMPLETE

Codes content summary table on p. 17



OB 1000

OB1000

FLOW RATE-MAX VACUUM	25 LPM - 850 mbar (85 kPa)
RATED VOLTAGE	12÷15 Vcc
AUTONOMY	60 minutes ±10%
AUTONOMY	IP 34d
BATTERY TYPE	SLA 12V - 4 Ah
WARRANTY	2 years
PERIODIC MAINTENANCE	2 years
RTCA DO160G	YES in AVIO version
DIMENSIONS	320×250(h)x100 mm
WEIGHT	3,5 kg with accessories (without wall bracket)



RELIABLE AND AVIO VERSION

Max. flow rate 25 liter/minute with double piston suction pump and max. vacuum rate 850 mbar. Available in AVIO version: conformed to RTCA DO 160G.

FA version: 1000 ml autoclavable canister with protection overflow valve and protection filter directly on the cover.
FM version: 1000 ml OB-J canister suitable for the use of Serres liners.



RECHARGING SYSTEM

Upon request the device can be supplied with a wall bracket (conformed to EN 1789) and with a 2-poles main power supply male connector.
Red transport bag.

BSU210	- OB1000 FA MEDICAL SUCTION UNIT
BSU216	- OB1000 FA MEDICAL SUCTION UNIT EU
BSU220	- OB1000 FA MEDICAL SUCTION UNIT COMPLETE
BSU232	- OB1000 AVIO FA MEDICAL SUCTION UNIT
BSU212	- OB1000 FM MEDICAL SUCTION UNIT
BSU226	- OB1000 FM MEDICAL SUCTION UNIT EU
BSU228	- OB1000 FM MEDICAL SUCTION UNIT COMPLETE
BSU230	- OB1000 AVIO FM MEDICAL SUCTION UNIT

Codes content summary table on p. 16

OB 1000 CODES INDEX



OB1000



12 VCC CABLE

BSU855: 2 poles recharging supplying cable



WALL BRACKET

BSU810: wall bracket



ALIMENTATORE

BSU895EU: 2 poles power supply 14,0 V

BSU210ST

OB1000 FA MEDICAL SUCTION UNIT



-

-

BSU216

OB1000 FA MEDICAL SUCTION UNIT EU

-



UK and JP/USA connections available upon request

BSU220ST

OB1000 FA MEDICAL SUCTION UNIT COMPLETE



-

BSU232

OB1000 AVIO FA MEDICAL SUCTION UNIT



-

-

BSU212

OB1000 FM MEDICAL SUCTION UNIT



-

-

BSU226

OB1000 FM MEDICAL SUCTION UNIT EU

-



UK and JP/USA connections available upon request

BSU228ST

OB1000 FM MEDICAL SUCTION UNIT COMPLETE



-

BSU230

OB1000 AVIO FM MEDICAL SUCTION UNIT



-

-

IT IS POSSIBLE TO REQUEST MAIN POWER SUPPLY ADAPTERS WITH PLUGS FOR UK AND JP/USA SOCKETS

OB2012 CODES INDEX



OB2012



12 VCC CABLE

BSU855: 2 poles recharging supplying cable



WALL BRACKET

BSU810: wall bracket



POWER SUPPLY

BSU895EU: 2 poles power supply 14,0 V

BSU150ST

OB2012 FA MEDICAL SUCTION UNIT



-

-

BSU154

OB2012 FA MEDICAL SUCTION UNIT + WALL BRACKET



-

BSU158ST

OB2012 FA MEDICAL SUCTION UNIT COMPLETE



UK and JP/USA connections available upon request

BSU100

OB2012 LINER MEDICAL SUCTION UNIT



-

-

BSU104

OB2012 LINER MEDICAL SUCTION UNIT + WALL BRACKET



-

BSU108

OB2012 LINER MEDICAL SUCTION UNIT COMPLETE



UK and JP/USA connections available upon request

IT IS POSSIBLE TO REQUEST MAIN POWER SUPPLY ADAPTERS WITH PLUGS FOR UK AND JP/USA SOCKETS

OB500 - STATIONARY MEDICAL SUCTION UNIT

JAR

STATIONARY SUCTION UNIT FOR AMBULANCES

Max. flow rate 30 liter/minute and max. vacuum rate 800 mbar. Cable for the connection to the vehicle lighter (12Vcc).
Dimensions: 9x8,5x6 cm
Weight: 4,6 kg

FA version: 1000 ml autoclavable canister with protection overflow valve and protection filter directly on the cover.
FM version: 1000 ml OB-J canister suitable for the use of Serres liners.



MODULE OR EMBEDDING

Available in MODULE or EMBEDDED version

- BSU464 - OB500 FM MEDICAL SUCTION UNIT UNDERWALL EMBEDDING
- BSU442 - OB500 FA MEDICAL SUCTION UNIT UNDERWALL EMBEDDING
- BSU462 - OB500 LINER MEDICAL SUCTION UNIT UNDERWALL EMBEDDING
- BSU414 - OB500 FM MEDICAL SUCTION UNIT MODULE
- BSU402 - OB500 FA MEDICAL SUCTION UNIT MODULE
- BSU412 - OB500 LINER MEDICAL SUCTION UNIT MODULE

JARS FOR BOSCAROL SUCTION UNIT



OB-J CANISTER FOR SERRES LINERS - BSU506

New canister OB-J for secretion collection made in polypropylene for medical use. The jar features one canister and one adapter that allows the use of the jar with the disposable liner produced by the company Serres (non included). Complete with "L" joint. The canister is vapour autoclavable at a max temperature of 121°C and at a pressure of 2bar (200kPa). The jar can also be disinfected accordingly to local hospital procedures. Capacity: 1000 ml.



OB-J FA CANISTER - BSU500

New autoclavable suction jar (121° C - 2 bar max.) with made in polypropylene for medical use. Complete of overflow security valve. The protection filter and the angular joint connector for the aspiration tube patient side are directly connected to the cover. Capacity of 1000 ml.



500 ML CANISTER - BSU504

Suction jar for medical suction units, made in autoclavable and shockproof Macrolon with pressure closing lid made in silicone-rubber. Complete with overflow valve. Capacity: 500 ml.

ACCESSORIES FOR BOSCAROL SUCTION UNIT



ASPIRATION PROBE

Jankauer rigid aspiration probe, complete of 180 cm long connecting tube with female connection. Patient aspiration using only one hand. Rigid canula instantly ready and easy to use. Vacuum regulation by the thumb of the hand. Suitable for every kind of medical secretion suction unit. Singularly sterile packaged.

126140107191 - RIGID PROBE COMPLETE
126140105C01 - YANKAUER
126140104021 - CONNECTING TUBE



SUCTION UNIT CATHETERS

Bronchial suction catheter with straight tip, single-use and sterile. Blunt, atraumatic tip with two elliptical staggered side holes. Made of non-toxic medical grade PVC, soft and with a satinised surface for easy insertion and removal. Phthalate-free. Colored connector, available in different sizes.

SC105003 - CATHETER BLACK CH10
SC125003 - CATHETER WHITE CH12
SC145003 - CATHETER GREEN CH14
SC165003 - CATHETER ORANGE CH16
SC185003 - CATHETER RED CH18
SC205003 - CATHETER YELLOW CH20



CATHETER JOINT FINGER TYP - 126140108001

Suction-catheter joint "FINGER TYP" supplied in sterile package. Hole for vacuum regulation.



SILICONE PATIENT TUBE - BSU902

Autoclavable medical silicone patient tube
Length: about 130 cm

ACCESSORIES FOR JARS FOR BOSCAROL SUCTION UNIT



SERRES DISPOSABLE BAG - 57157

SERRES disposable cartridge 1000 ml with lid and integrated antibacterial filter. Exclusively compatible with suction units equipped with OB-J bottle (BSU506). Class I EC medical device.



PROTECTION FILTER FOR OB-J FA JAR

Disposable protection filter with PTFE filter holder and hermetic polypropylene container.

Max. applicable pressure up to 1 bar (100kPa). Mandatory for suction units as per ISO 10079-1:1999.

It is a CE medical device.

Device sold individually and available in two codes BSU999 and M03.1.003. The two codes have similar technical features and functions.

BSU999 - PROTECTION FILTER

M03.1.003 - PROTECTION FILTER

OTHERS SUCTION UNITS



STERILE NEWBORN SUCTION UNIT - 400100

Sterile newborn suction unit.
Lightweight, economic and efficient.
Suitable inside newborn reanimation cases
and sets. Disposable.

RECHARGING AND SUPPLYING SYSTEM FOR SUCTION UNITS



OB WB WALL BRACKET - BSU810

Wall bracket anchorage for OB2012, OB3000 and OB1000 medical suction units. Anchorage system which integrates the recharging system. Anchorage system tested up to 10g capacity as obligatory as per EN 1789 directive. Complete with cable for the connection to the ambulance electric system. 12V power supply for OB2012 and OB1000; 11÷30V power supply for OB3000. Weight: about 0,8 kg
Dimensions: about 240 x 255 x 5 mm



MAIN POWER SUPPLY ADAPTER 2 P 14,0 V

2-pole male connection cable complete with retaining ring for BSU. Wide range input voltage: 100÷240VAc can be used at 50 or 60 Hz. Output voltage 14 Vcc. Delivered rated power: 5 Adc. It can be connected the suction unit while operating on the patient. It is an accessory of medical device and is CE marked. Available in EU, UK and JP version.

BSU895EU - POWER SUPPLY 14,0 V 2P - EU
BSU895UK - POWER SUPPLY 14,0 V 2P - UK
BSU895JP - POWER SUPPLY 14,0 V 2P - JP

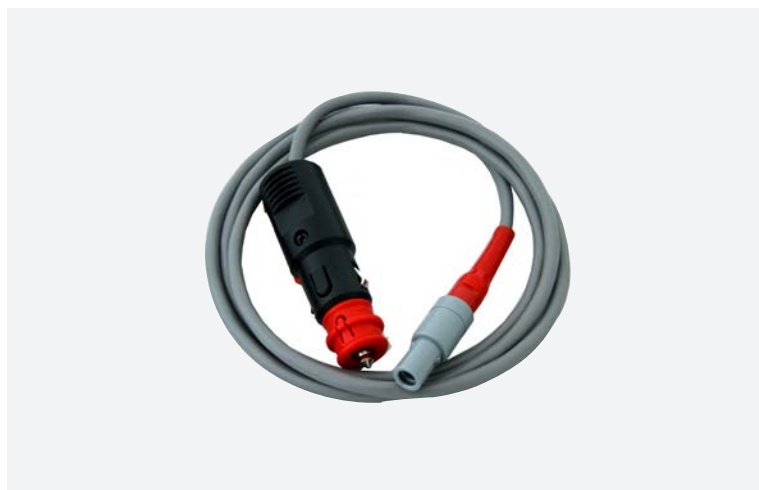

RECHARGING-SUPPLYING CABLE 2P 12 V - BSU855

2 poles recharging and power supply cable for Medical Suction Units models. Supplied with universal car lighter plug.



PRACTICAL AND RESISTANT

Our rescue rucksacks are designed to guarantee practicality and resistance. We personally check the quality of our productions to provide even better products.

EMERGENCY RUCKSACKS



EMERGENCY RUCKSACK VIPER 2.0 - BOR87000N-S

Rescue Rucksack Viper made of red nylon. The tear-proof and waterproof fabric allows safe use even in precarious weather conditions. Equipped with double handle (upper or lateral) for easier transport. Equipped with front, side and rear reflective strips (on padded shoulder straps). The part in contact with the back of the user is equipped with cushions. Large front opening pocket with 2 internal elastic bands for the fixing of material. 3 external perimeter pockets: two little ones at the ends of the second handle and a big one on the opposite side. 8 removable coloured pouches with transparent front and Velcro strips. Internal central partition with zipper, complete with elastic bands for the fixing medical devices. Reinforced bottom and rubber feet. Dimensions: about 46x26x50cm. Weight: about 3.8kg.



EMERGENCY RUCKSACK MASTERMED 2.0 - BOR87020N

Mastermed Rucksack with Edition 2019 internal structure made of red nylon. The tear-proof and waterproof fabric allows safe use even in precarious weather conditions. The two front pockets are made with transparent internal compartments that are easy to open. The front pocket is equipped with elastic bands for the fixing medical devices of different sizes. The shoulder straps are padded and equipped with reflective strips along their entire length. Rucksack with 8 coloured inner bags with transparent front, 4 of which with handle. The part in contact with the back of the user is equipped with cushions. Dimensions: about 35x30x53cm. Volume: about 43 litres. Weight: about 4.3kg.

EMERGENCY RUCKSACKS



EMERGENCY RUCKSACK MAXIMED - BOR87010N

Red tearproof and water-proof material. Front, side and rear reflective strips (on padded shoulder straps). The part in contact with the back of the user is equipped with cushions. 2 front pockets, 2 side pockets, one with 4 coloured pouches. 4 removable coloured pouches. Oxygen cylinder holder straps placed centrally. Dimensions: 48x30x52 cm. Volume: about 54 litres. Weight: about 4,5 kg.



RESPONDER BAG RESCUE BACKPACK - BOR87050

RESPONDER BAG rescue backpack. Tear-proof and waterproof red fabric. Equipped with: top handle for easy carrying; large, full-opening front pocket with 1 strip of elastic on the inside and 2 on the outside for securing materials; 2 small side pockets; front and side reflective strips; 6 removable coloured pouches with transparent front and Velcro-type strips; reinforced bottom and rubber feet. The part in contact with the back is equipped with shock-absorbing cushions. Dimensions: approx. 42x23x46 cm. Weight: approx. 1.5 kg.

EMERGENCY RUCKSACKS



ATLS MODULE RESCUE RUCKSACK - BOR81146N

ATLS modular rescue backpack. Made of tear-proof and waterproof Nylon. Reflective strip on padded shoulder straps for better visibility. Transparent front window for logos. Large front pocket allows safe storage of large medical devices. Soft back pads to reduce back fatigue. Chest strap for easier carrying. Rigid shockproof polypropylene tub with 4 rigid subdivisions for storing bags. 4 inner removable coloured pouches with transparent fronts. Dimensions: approx. 32x25x53 cm. Volume: approx. 35 l. Weight: approx. 3.3 kg.

EMERGENCY TROLLEY



MASTER TROLLEY - BOR87220R

Rucksack Master Trolley empty, suitable for carrying materials in between hospital departments. Made of red tearproof fabric. 2 reflective strips, pull-out trolley handle, pull-out padded shoulder-strap. 2 frontal pockets which might be equipped with additional material, 4 removable coloured pouches with transparent front. Dimensions: about 31x37x58 (h) cm. Weight: about 5,5 kg.



RESPONDER TROLLEY - BOR87051

RESPONDER TROLLEY backpack, ideal for transporting material in hospital wards. Tear-proof Cordura type fabric in red colour. Equipped with: 2 reflective strips; retractable trolley handle; padded shoulder straps; 2 equipped front pockets; inner compartment with tank holder and two mesh pockets; 3 removable coloured pouches with transparent front. Dimensions: approx. 42x28x57 cm. Weight: approx. 3.5 kg.

TRAUMA BAG

TRAUMA BAG 10 - BOR89040

Easy to carry either by hand, on shoulder or as a backpack
4 external lateral pockets, 2 with elastics, 4 inner modular spaces,
1 inner removable pouch with transparent frontal
Dimensions: about 45x33x30(h) cm.
Weight: about 2,2 kg.



TRAUMA BAG 20 - BOR89050

Easy to carry either by hand, on shoulder or as a backpack. 4 external lateral pockets, 2 with elastics, 5 inner modular spaces, 1 inner removable pouch with transparent frontal.
Dimensions: about 53x33x34(h) cm
Weight: about 2,2 kg

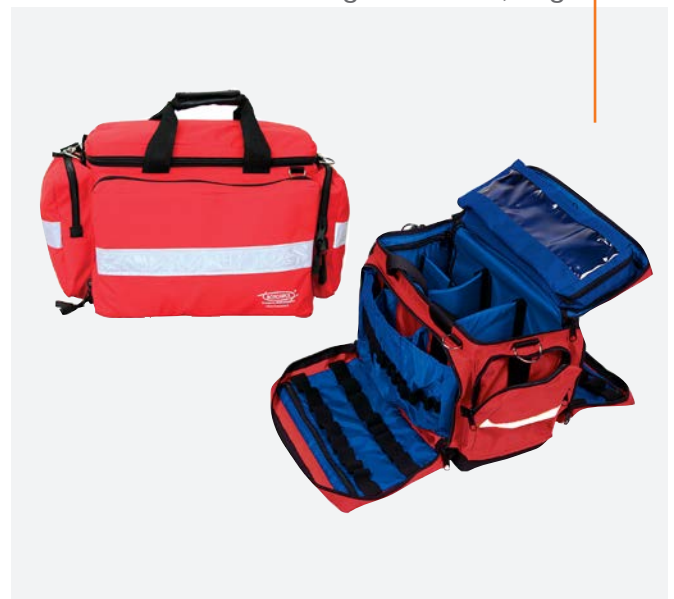

TRAUMA BAG 30 - BOR89060

Easy to carry either by hand, on shoulder or as a backpack. 5 external lateral pockets, 3 with elastics, 5 inner modular spaces, 2 inner removable pouches with transparent frontal.
Dimensions: about 63x37x31(h) cm
Weight: about 2,3 kg.



BOR89040 - TRAUMA BAG 10 RED
BOR89050 - TRAUMA BAG 20 RED
BOR89060 - TRAUMA BAG 30 RED

Pediatric edition of TRAUMA BAG is available (p. 31)

EMERGENCY BAGS



33 BAG - BOR87300R

Made of red tearproof and impermeable fabric material. 1 capacious outer pocket. 5 inner adjustable spaces. Inside provided with elastics and a documents pocket. 1 transparent frontal pocket for association logo.

Dimensions: about 36x18x35(h) cm.

Weight: about 1,6 kg.



PROFI BAG MINI - BOR89000R

Made of impermeable and tearproof red fabric material. With handle and shoulder straps. Modular interior. 2 wide lateral external pockets. Internal pocket with transparent.

Dimensions: about 36x26x20(h) cm.

Weight: 0,7 kg.



PROFI BAG - BOR89010

Made of impermeable and tearproof red fabric material. With handle and shoulder straps. Modular interior. 1 frontal pocket. Arranged to hold 1-2 lts oxygen cylinder. 2 wide lateral external pockets. Internal pocket with transparent.

Dimensions: about 60x25x27(h) cm.

Weight: 1,4 kg.

EMERGENCY BAGS

MINI RESCUE BAG - BOR80290

Compact and practical emergency bag. Hand and shoulder transportable. Made in tearproof and waterproof material. 2 windows for the insertion of identity cards/logos. Lower part with inner shockproof basin. Upper part with elastics. Size: about 39 x 18 x 25h cm. Weight: about 1 kg.



KANGOO BAG - BOR88030

Made of tear-resistant fabric in red color. Possibility to wear it on the belt or shoulder. High-visibility reflective tape. Equipped with a large main body consisting of 1 large front pocket and 2 side pockets. Dimensions: about 34x16x12.5



TRAUMA BAG 10 PEDIATRIC - BOR89040PR

Made of tear-proof and waterproof nylon. The fabric has bright colours and textures suitable for use in the paediatric sector. Completely removable and washable according to the specified conditions. 4 reflective strips placed on the sides of the bag. Handles, belt and shoulder straps for comfortable and safe transport. 2 external side pockets with internal spaces and elastic bands. The inside of the bag is divided into 4 separate spaces that can be removed. In the upper part there is a removable bag with a transparent front. Dimensions: about 44x30x29 cm. Weight: about 2.1 kg.



OXYGEN CILYNDER BAGS



OXIBAG BLUE - BOR87040

Padded oxygen cylinder case. Waterproof and tear-proof high-strength PVC fabric. The shape and padding allow the oxygen cylinder to be safely contained, protected and transported. Can hold 1 or 2 l oxygen cylinders. Dimensions: approx. 54x23x24 cm. Weight: approx. 1.1 kg.



OXIBAG CORDURA RED - BOR87041

Padded oxygen cylinder case. High-strength, tear-proof nylon fabric. The shape and padding allow the oxygen cylinder to be contained, protected and transported with absolute safety. Can hold 1 or 2 l oxygen cylinders. Dimensions: approx. 54x23x24 cm. Weight: approx. 0.8 kg.

DRUGS BAGS



DRUGS BAG 28 PHIALS - BOR89330

Book-opening drugs case empty. Made in tearproof impermeable red fabric material. 2 rear Velcro-strips for the fixing in bags and emergency rucksacks. 2 removable plates with elastics suitable for 28 different sized phials. Central padding for ampoules record. Dimensions: about 25x12x7(h) cm. CE medical device.



DRUGS BAG 84 PHIALS - BOR89332

Big book-opening drugs bag. 2 parts with adjustable elastics to feature 84 different sized phials. Central padding with transparent pocket for ampoules list and expiry date. Made in red, tear-resistant, water-resistant material. 2 external Velcro-strips for the fixing in bags or rucksacks. Dimensions: about 25x25x7h cm. CE medical device.

POUCHES



BLUE DOUBLE POUCH - BOR81042

Dimensions: about 25x25x8 cm



VIPER POUCHES

Dimensions: about 19x12x6 cm
Velcro-strips: female

BOR81058R- YELLOW VIPER POUCH
BOR81060R- GREEN VIPER POUCH
BOR81062R- RED VIPER POUCH
BOR81064R- BLUE VIPER POUCH



MINI POUCHES

Dimensions: about 15x12x8,5 cm

BOR89458R - MINI POUCH BLACK
BOR89460R - MINI POUCH RED
BOR89462R - MINI POUCH BLUE
BOR89464R - MINI POUCH GREEN



STANDARD POUCHES

Dimensions: about 27x12x9 cm

BOR81024 - STD POUCH PINK
BOR81028 - STD POUCH RED
BOR81030 - STD POUCH GREEN
BOR81032 - STD POUCH YELLOW
BOR81034 - STD POUCH BLUE

POUCHES



BIG POUCHES WITH HANDLE

Dimensions: about 30X12X13 cm

BOR89440R - GREEN BIG POUCH WITH HANDLE
BOR89442R - RED BIG POUCH WITH HANDLE
BOR89444R - BLUE BIG POUCH WITH HANDLE
BOR89446R - YELLOW BIG POUCH WITH



POUCHES WITH HANDLE

Dimensions: about 23x14x11 cm

BOR89420R - YELLOW POUCH WITH HANDLE
BOR89422R - BLUE POUCH WITH HANDLE
BOR89424R - GREEN POUCH WITH HANDLE
BOR89426R - RED POUCH WITH HANDLE



FABRIC BAG - BOR84072

Fabric empty bag. Tearproof impermeable blue material. With shoulder strap.
Dimensions: about 29x16x16 cm.
Weight: about 210 g. Supplied empty.



ROLL-CASE FOR LARYNGOSCOPE - BOR84041

Roll-case for laryngoscope - red
5 inner compartments.
Made in washable cloth with inner stuffing.
Dimensions: about 19x34 cm.

FIRST AID AND WAIST POUCHES



FIRST AID POUCH- BOR87061

Made of tear-proof and waterproof red fabric. Equipped with 2 net pockets for rescue equipment. Suitable for belt transport.

Dimensions: approx. 15x10x23 cm.
Weight: 130 g approx.



WAIST POUCH - BOR87060

Made of red waterproof tear-proof fabric. Equipped with a large front pocket. Dimensions approx. 32x12x12 cm

EMPTY/COMPLETE E-HOLSTER AND HOLSTER



EMPTY E-HOLSTER

E-Holster belt made in tearproof and water-resistant red material. 5 compartments with pockets for gloves and for Pen Light. Belt loop of about 5,5 cm. Dimensions: about 14x3x19(h) cm. Weight: about 100 g. Supplied empty.

BOR84062 - BLUE EMPTY E-HOLSTER
BOR84063 - RED EMPTY E-HOLSTER



COMPLETE E-HOLSTER

E-Holster belt made in tearproof and water-resistant red material. 5 compartments with pockets for gloves and for Pen Light. Belt loop of about 5,5 cm. Complete with: 1 first aid scissors, 1 anatomic forceps, Cocher forceps, 1 Pen Light, 1 Tourniquet. Dimensions: about 14x3x19(h) cm. Weight: about 200 g.

BOR84064 - BLUE COMPLETE E-HOLSTER
BOR84065 - RED COMPLETE E-HOLSTER

CABINETS



CABINET - CAV605

Carbon steel cabinet, coated in epoxy polyester. Rounded edges. Three steel shelves. Door with 3 accessories holder. Locker with key.
Dimensions: 402x202x483(h) mm.
Weight: 6,60 kg. Supplied empty.

ALUMINIUM CASES



ALUMINIUM CASE TYPE A - VAL42000

Type A emergency medical case made of anodized aluminium. High resistance and long durability. Inside made in washable and disinfectable thermo-format with modular system. Arranged to accommodate oxygen cylinders (1 or 2 litres).

Dimensions: about 52x36x17(h) cm.

Weight: about 5,7 kg. Supplied empty.

VAL42000 - ALUMINIUM CASE TYPE A
VAL42010 - 2 AMPOULE HOLDER RAIL
DEPOT FOR CASE TYPE A



ALUMINIUM CASE TYPE B - VAL43000

Type B emergency medical case, made of anodized aluminium. High resistance and long durability. Inside made in washable and disinfectable thermo-format with modular system. Arranged to accommodate oxygen cylinders (1 or 2 litres). Removable internal basin made in thermo-format with rail ampoules holder (max 60 pcs).

Dimensions: about 52x36x24(h) cm.

Weight: about 7,6 kg. Supplied empty.

CASES IN ABS



MEDIC CASE IN ABS

Medic 2 case empty with orange or transparent cover. Made in shockproof orange ABS material. Equipped with wall bracketing. Dimensions: about 39,5x13,5x26(h) cm. Weight: about 1,6 kg.

CAV399 - MEDIC 2 CASE TRANSPAR. COVER
CAV401 - MEDIC 2 CASE ORANGE COVER



MULTI CASE IN ABS - VAL40110

Multi type case empty. Made in orange shockproof ABS material. Wall bracket anchorage system. 2 equal sides made of 2 adjustable inner compartments. 2 transparent dividers. Dimensions: about 42x15x30(h) cm. Weight: about 3,3 kg.



FLEXI CASE IN ABS - CAV406

Flexi case empty. Made in shockproof orange polypropylene material. Equipped with wall bracketing. Dimensions: about 25,5x9x19,5 (h) cm. Weight: about 0,45 kg.

WATER PROOF CASES



BOSCAROL HIGH IMPACT CASE

Boscarol High Impact small orange case with high resistant thick walls. Automatic pressure release valve. Easy to open double throw latches. Load tested soft grip handle. Holes for double padlocking. Holes for shoulder strap. Stackable interlocking system. Thick body material. Extra fixing points. Fully length hinges. Nylon pins, corrosion free. Pick N Pluck foams in the bottom and convoluted foam available on demand. Screen printing space on the lid. Rectangular resin label space on the lid.

Available in 3 sizes:

Small: about 33,6x30x14,8 cm.

Weight: 1,75 kg.

Medium: 46,4x36,6x17,6 cm.

Weight: 2,78 kg.

VAL43140 - SMALL BOSCAROL HIGH IMPACT CASE
VAL43141 - MEDIUM BOSCAROL HIGH IMPACT CASE
VAL43142 - LARGE BOSCAROL HIGH IMPACT CASE



EXPLORER CASE

Emergency waterproof and watertight case up to 10 meters deep. With pressurization valve. Sturdy closing system with predisposition for a lead lock.

Available in different sizes.

EXPLORER MINI

Dim.: 30,5x19,5x27h cm - Weight: 1,9 kg

EXPLORER P

Dim.: 41x20,5x34 cm - Weight: 3,1 kg

EXPLORER M

Dim.: 52x23x43,5 cm - Weight: 4,6 kg

EXPLORER

Dim.: 44,5x34,5x19 cm - Weight: 4 kg

EXPLORER G

Dim.: 65x24x51 cm - Weight: 7,1 kg

VAL43151 - EXPLORER MINI
VAL43152 - EXPLORER P
VAL43162 - EXPLORER M
VAL43164 - EXPLORER
VAL43172 - EXPLORER G
VAL43174 - EXPLORER P WITH 4 POUCHES
VAL43176 - EXPLORER M WITH 5 POUCHES
VAL43178 - EXPLORER G WITH 6 POUCHES



PRODUCTS FOR HEALTH EMERGENCY

Our immobilization and transport medical devices meet the standards in force when expected and were born from the desire to provide products dedicated to the specific sector of health emergency.

MADE IN ITALY

The MADE IN ITALY manufacturing allows us to offer high quality medical devices, by verifying and tracing every phase of the production process.

SUCTION VALVE



All our vacuum medical devices are equipped with a suction valve specifically designed and patented by Oscar Boscarol srl.

VACUUM MATTRESSES

SDM - IMM120012



SDM vacuum mattress, made of high-strength fabric, intended for the immobilisation and transport of polytrauma patients. Equipped with 8 handles for lifting and transportation. Suction valve located close to the head on the outer side, easily accessible even with immobilized patient. Equipped with 3 immobilisation straps
Radio-transparent. Equipped with 3 internal suction chambers for better adaptation to the anatomical shape of the patient.
Dimensions: 200x80x6h cm

Weight: 7 kg

In compliance with the standard EN 1865-11t is a CE medical device in compliance with the European Regulation MDR 2017/745

IMM120012 - SDM VACUUM MATTRESS
XIMM120014 - SDM VACUUM MATTRESS
COMPLETE WITH BAG AND PUMP

PROFI - IMM120150



PROFI vacuum mattress, made of high-strength fabric, intended for the immobilisation and transport of polytrauma patients. The mattress includes a semi-rigid support in which 8 handles for lifting and transport are located. Suction valve located close to the head on the outer side, easily accessible even with immobilized patient. Equipped with 3 immobilisation straps
Radio-transparent. Equipped with 3 internal suction chambers for better adaptation to the anatomical shape of the patient.
Dimensions: 205x95x10h cm

Weight: 10 kg

In compliance with the standard EN 1865-1 It is a CE medical device in compliance with the European Regulation MDR 2017/745

IMM120150 - PROFI VACUUM MATTRESS
XIMM120130 - PROFI VACUUM MATTRESS
COMPLETE WITH BAG AND PUMP

VACUUM MATTRESSES

PROFI EVOLUTION - IMM120129



PROFI EVOLUTION vacuum mattress, made of high-strength fabric, intended for the immobilisation and transport of polytrauma patients. The mattress includes a semi-rigid support in which 8 handles for lifting and transport are located. Suction valve located close to the head on the outer side, protected by the semi-rigid support, easily accessible even with immobilized patient. Equipped with two specific holes for fixing the mattress to metal stretchers used in air rescue operations. Equipped with 3 immobilisation straps. Radio-transparent. Equipped with 3 internal suction chambers for better adaptation to the anatomical shape of the patient.

Dimensions: 205x95x10h cm

Weight: 8.2 kg

In compliance with the standard EN 1865-1
It is a CE medical device in compliance with the European Regulation MDR 2017/745

IMM120129 - PROFI EVOL. VACUUM MATTRESS
XIMM120131 - PROFI EVOL. VACUUM
MATTRESS COMPLETE WITH BAG AND PUMP

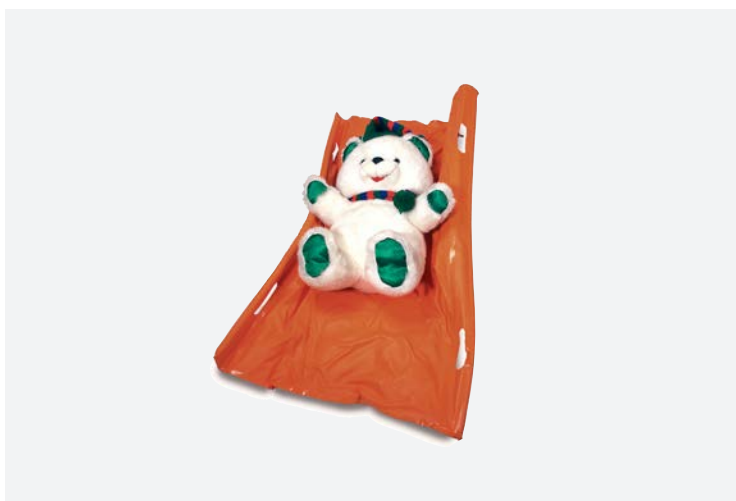

BABY - IMM120060

BABY vacuum mattress, made of high-strength fabric, intended for the immobilisation and transport of children. Equipped with 4 handles for lifting and carrying.

Suction valve located close to the head on the outer side, easily accessible even with immobilized patient.

Radio-transparent

Dimensions: 87x65x4h cm

Weight: 1.6 kg

Max. load capacity: 18 kg

VACUUM SPLINT

VACUUM SPLINT



High resistant and washable material. Quick and painless immobilization of all kind of fractures (even exposed ones). Immobilizes without constrictions thus allowing blood circulation. External aspiration valve. 100% X-ray transparent (any metal parts included). Suitable for use on baby patients.

CE medical device.

Dimension hand vacuum splint: 50,5x33 cm.

Dimension arm vacuum splint: 75x47 cm.

Dimension leg vacuum splint: 92x64 cm.

Dimension leg 108 vacuum splint: 108x64 cm. Singularly or in set packaged, complete with transport bag or transport bag and suction pump.

IMM120172 - VACUUM SPLINT LEG 108CM

IMM120174 - VACUUM SPLINT HAND

IMM120176 - VACUUM SPLINT ARM

IMM120178 - VACUUM SPLINT LEG

IMM120200 - SET 2 VACUUM SPLINT WITH TRANSPORT BAG

IMM120180 - SET 2 VACUUM SPLINT COMPLETE (TRANSPORT BAG AND SUCTION PUMP)

IMM120190 - SET 3 VACUUM SPLINT WITH TRANSPORT BAG

IMM120184 - SET 3 VACUUM SPLINT COMPLETE (TRANSPORT BAG AND SUCTION PUMP)

IMM120218 - TRANSPORT BAG FOR VACUUM SPLINT

ACCESSORIES FOR VACUUM DEVICES



ALUMINIUM MAXI SUCTION PUMP - IMM120240

Suction pump for vacuum mattress and splints
Made in aluminium with foot support for easy aspiration.

Dimensions: about 13x5,5x54(h) cm

Weight: about 1,4 kg



ALUMINIUM MINI SUCTION PUMP - IMM120260

Suction pump for vacuum mattress and splints. Made in aluminium.

Dimensions: about 4x32 cm

Weight: about 500 g



TRANSPORT BAG FOR VACUUM MATTRESS - IMM120030

Transport bag for vacuum mattress.
Tearproof impermeable material.
Transport handles.

Dimensions: about 89x24x72(h) cm



REPAIR KIT- AIM5000

It contains five pieces of pvc fabric and a bottle of special glue: make sure the damaged spot is not covered with oil or grease, clean it thoroughly and make it rough. Apply the special glue and let it dry (check with the back of the fingers). Apply the fabric with firm pressure to that area. Check the seal.

RIGID SPLINT AND SSPLINT

RIGID SPLINT



Rigid splint for upper/inferior limbs immobilization. Made in PVC and Nylon. Washable and X-ray transparent. Velcro closing. Dimensions upper limbs: about 51x27,5x3,5 cm. Dimensions inferior limbs: 74x40x3,5 cm. Available in set of 2 vacuum splints complete with transport bag.

IMM123100 - UPPER LIMBS RIGID SPLINT
IMM123110 - INFERIOR LIMBS RIGID SPLINT
IMMM123120 - SET 2 RIGID SPLINT WITH TRANSPORT BAG

SSPLINT

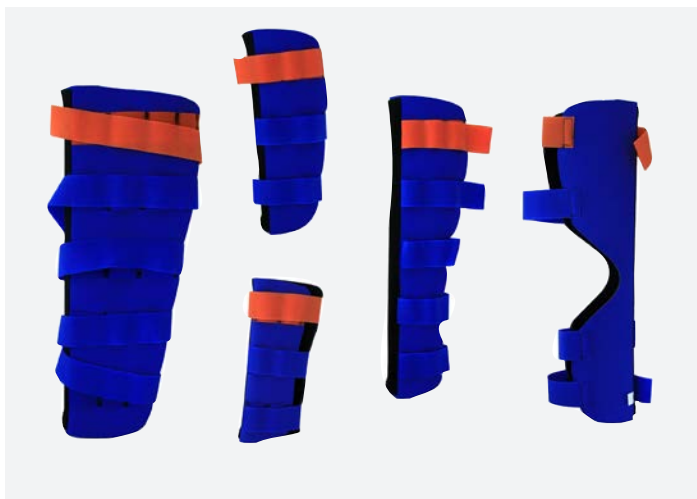

Splint system set with aluminium core for easy limbs immobilization in case of fracture or sprain. Made in neoprene material. Adaptable to fit each body frame. It does not cause tissue compressions. It maintains body temperature. It reduces congestion around injured areas. Velcro modelling closing. Lightweight and easily washable even in washing-machine. Least encumbrance. Dim. leg ssplint: 58x21x0,6 cm (not suitable for femur fractures). Dim. arm ssplint: 60,5x17x0,6 cm. Dim. forearm ssplint: 39x16x0,6 cm. Dim. wrist ssplint: 32x15x0,6 cm. Dim. ankle ssplint: 57x18x0,6 cm. Set of 5 vacuum splints complete with bag.

IMM124030 - SSPLINT OB SET 5 PCS WITH BAG
IMM124031 - SSPLINT OB LEG
IMM124032 - SSPLINT OB ARM
IMM124033 - SSPLINT OB FOREARM
IMM124034 - SSPLINT OB WRIST
IMM124035 - SSPLINT OB ANKLE
IMM123154R - RED BAG FOR SSPLINT



ROLLSPLINT - FS230

Conformable splint for fractures
Lightweight, washable and disinfectable
Coated with non-toxic material
Non radiolucent
Dimensions: approx. 91x11 cm

FIRST RESPONSE ONE-PIECE CERVICAL COLLARS

One-piece cervical collar, made with injection mould system. Perfect immobilization of cervical section. Frontal opening for trachea check. Made of polypropylene X-ray transparent with non absorbent padding. CE medical device. Available in different sizes and in set of 2,3, 4 or 6 collars complete with transport bag.



0 INFANT PINK - IMM124100

Size: 0 - Infant pink



1 PEDIAT. LIGHT BLUE - IMM124102

Size: 1 - Pediatric light blue



2 NECKLESS VIOLET - IMM124104

Size: 2 - Neckless violet



3 SHORT BLUE - IMM124106

Size: 3 - Short blue



4 REGULAR ORANGE - IMM124108

Size: 4 - Regular orange



5 TALL GREEN - IMM124110

Size: 5 - Tall green



SET OF 3 OR 4 COLLARS

IMM124112: set of 3 OB NEW one-piece collars (size from 1 to 3) with transport bag.

IMM124114: set of 4 OB NEW one-piece (size from 1 to 4) with transport bag.



SET OF 6 COLLARS - IMM124116

Set of 6 OB NEW one-piece collars (sizes from 0 to 5), with transport bag.

IMM120656: transport bag.



SET OF 2 COLLARS - IMM124118

Set di 2 OB NEW one-piece collars (sizes 0 and 1), with transport bag.

TWIN ART TWO-PIECES CERVICAL COLLARS

Two-pieces cervical collar, made with injection mould system. Perfect immobilization of cervical section. Frontal opening for trachea check. Made of polypropylene X-ray transparent with non absorbent padding. CE medical device. Available in different sizes and in set of 2,3 or 6 collars complete with transport bag.



0 INFANT PINK - IMM120782

Size: 0 - Infant pink



1 PEDIAT. LIGHT BLUE - IMM120784

Size: 1 - Pediatric light blue



2 NECKLESS VIOLET - IMM120786

Size: 2 - Neckless violet



3 SHORT BLUE - IMM120788

Size: 3 - Short blue



4 REGULAR ORANGE - IMM120790

Size: 4 - Regular orange



5 TALL GREEN - IMM120792

Size: 5 - Tall green



SET 3 COLLARS - IMM120794

Set of 3 OBNECK two-pieces collars (sizes from 1 to 3), complete with transport bag.



SET 6 COLLARS - IMM120796

Set of 6 OBNECK two-pieces collars (sizes from 0 to 5), complete with transport bag.

IMM120653 - TWO-PIECES COLLARS TRANSPORT BAG
IMM120658 - FANTASY TWO-PIECES COLLARS TRANSPORT BAG

ADJUSTABLE CERVICAL COLLARS



ADJUSTABLE COLLARS CHAMPION

Double valve collar adjustable in different heights. Allows immobilization of the cervical spine, minimizes flexion-extension and ensures better control of axial rotation and lateral flexion movements. Central hole for the control of the trachea and the execution of a tracheotomy procedure. The end of the Velcro is in orange color for a better identification of the grip. Polyethylene structure, black LD padding, nylon buttons and Velcro strap latch. Radiotransparent - Latex-Free - Unsterile - Single-use - Disposable.

9030 - CHAMPION COLLAR ADULT

9031 - CHAMPION COLLAR PEDIATRIC



ADJUSTABLE COLLARS FAST

Cervical collar adjustable to different heights. Allows immobilization of the cervical spine and minimizes flexion-extension. Central hole for the control of the trachea and the execution of a tracheotomy procedure. Polyethylene structure, black LD padding, nylon buttons and Velcro strap latch. Radiotransparent - Latex-Free - Unsterile - Single-use - Disposable.

9015 - FAST COLLAR ADULT

9015PED - FAST COLLAR PEDIATRIC



ADJUSTABLE COLLARS PATRIOT

Cervical collar 4 positions adjustable (Low, Short, Regular and Tall). Simple and versatile usage. Excellent immobilization. Wide frontal opening allowing an adequate access to windpipe. Easily washable. X-Ray transparent.

PHP-PA - PATRIOT ADULT

PHP-PP - PATRIOT PEDIATRIC

PHP-PA-G - PATRIOT ADULT OLIVE GREEN

CERVICAL COLLARS AND IMMOBILIZATION DEVICES



STIFNECK COLLARS

Stifneck cervical collar with 4 sizes (Low, Short, Regular e Tall). Frontal opening for windpipe check. Easy to wash. X-ray transparent.

IMM120648 - STIFNECK ADULT COLLAR
IMM120650 - STIFNECK PEDIATRIC COLLAR



ECO COLLARS

Cervical collar made in high density Elastolen/ Veolene, non-deformable (closed cells polyethylene) resistant to external agents, totally non-toxic. Velcro closing. X-ray transparent.

IMM120776 - ECO COLLAR SMALL N. 0
IMM120774 - ECO COLLAR MEDIUM N. 2
IMM120778 - ECO COLLAR BIG N. 3
IMM120770 - SET 3 ECO COLLARS (0-2-3)



SOFT COLLARS

Soft collars for cervical immobilization. Structure in high density foam rubber with tubular cotton jersey covering. Velcro closing.

IMM120830 - SOFT COLLAR SIZE S
IMM120832 - SOFT COLLAR SIZE M
IMM120834 - SOFT COLLAR SIZE L
IMM120836 - SOFT COLLAR SIZE XL



RESCUE CAN - 6400300

Rescue can, rescue buoy, light and imperishable. Printed in high density polyethylene without joints. Endowed with floating 186 cm rope and shoulder strap. Non-homologated by nautical authorities. It is not a medical device.

Dimensions: about 23x16x68 cm.
Weight: about 1,2 kg.

OB SPINAL BOARD AND TRANSFER SHEET

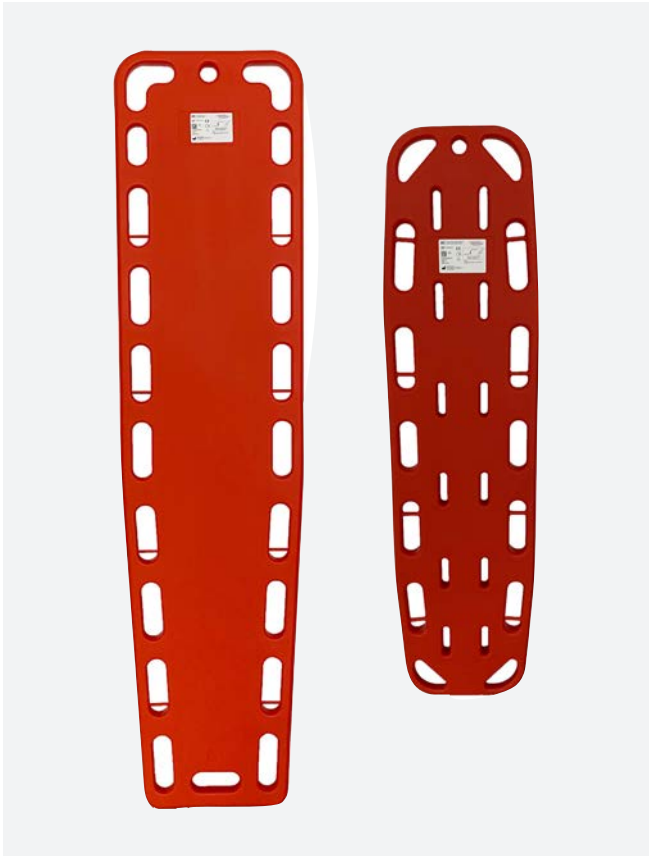

OB SPINAL BOARD

Professional-grade medical device intended for immobilization and transport, in a horizontal position, of patients with spinal or limb trauma. Entirely made of plastic material (PE) with radiotranslucent and waterproof characteristics. Equipped with: 21 carrying handles (10 arranged on each long side and 1 on the short side of the stretcher at the patient's foot position). 2 safety belts for secure immobilization of the patient. Dimensions: 182X45X6 cm approx. Weight: 8.15 kg approx. Maximum load capacity: 150 kg. It is a CE medical device in accordance with European Regulation MDR 2017/745.

IMM121074A - OB SPINAL BOARD
IMM121074P - PEDIARIC OB SPINAL BOARD



TRANSFER SHEET - IMM120321

New transfer sheet, even more resistant. Made of red tearproof impermeable PVC material. 8 side handles. Easily washable and disinfectable. Perimeter reinforced with a 4cm, double sewn band on both sides. Dimensions: about 187x70 cm. Weight: about 1200 g. Loading: about 150 kg. In accordance to EN1865-1 norm.

UNIVERSAL HEAD IMMOBILIZER



OB HEAD IMMOBILIZER - IMM121631R

Made of treated, water-repellent high-density foam in red color
Consists of 1 base cushion, 2 head support pads with opening for ear access, 2 chin rests with central padding and 8 straps, 2 tape straps with Velcro already integrated at the base for positioning the head immobilizer on the stretcher
Radio-transparent
Dimensions: 40x26x16 cm approx.
Weight: 880 g approx.

IMM121631R - OB HEAD IMMOBILIZER
IMM121631P - PEDIATRIC OB HEAD IMMOBILIZER



WIND HEAD IMMOBILIZER - IMM121640

Realized in stuffed MDF and covered with washable, disinfectable, water repellent and thermo-welded material. 2 head-fixing-pillows with opening for access to the ears are integrated at the base and are part of the base itself if not used. Allows fixed head immobilizer storage with stretcher. Complete of 2 chin straps and 2 Velcro straps, 8 belts with loop and 2 velcro bands for the fixing to the spinal board. X-ray translucent.
Dimensions: about 44,5x30x2,5 cm
Weight: about 1,2 kg

IMM121640 - WIND HEAD IMMOBILIZER
IMM121634 - SET OF 2 CHIN-STRAPS FOR WIND HEAD IMMOBILIZER
IMM121652 - SET OF 4 HEAD IMMOBILIZER BELTS
IMM121654 - SET OF 2 VELCRO STRAPS FOR WIND HEAD IMMOBILIZERS

IMMOBILIZATION BELTS

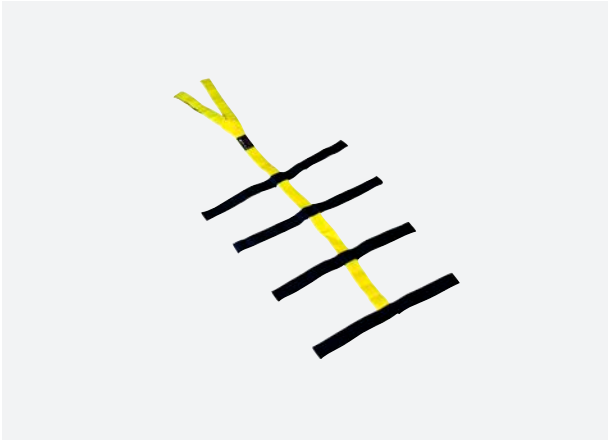

SPIDER IMMOBILIZATION BELTS - IMM121033

Allows the immobilization of an adult or paediatric patient on a generic spine board. Made with 1.2 mm thick polyester webbing to ensure high fastening strength and durability. Thanks to the possibility of moving the straps according to the type of patient, (along the vertical axis of the fastening system) it is possible to secure the patient in a stable and safe way. The straps are fastened to the patient's body thanks to 5 cm wide Velcro strips which make both closing and opening operations easy and safe. Complete with a practical case.

CTS - CHILDREN TRANSPORT UNIT - IMM120050

PEDIATRIC EMERGENCY TRANSPORT

Children transport system with pediatric fabric. Complete of safety-belts allowing to block the newborn in 3 positions, avoiding children usual dangerous and unexpected movements.



FROM 1 TO 24 MONTHS

The device is intended to be used for new-born and children transport, approximately from 1 to 24 months old (shoulder / crotch length from 35 to 87 cm).



ANCHORAGE TO THE STRETCHER

3 external safety belts allowing child further fastening. 3 belts allowing the fixing of the CTS to the stretcher. Complete of transport bag. CE medical device. Dimensions: about 110x70 cm



INFANT TRANSPORT UNIT - IMM120071

NEWBORN EMERGENCY TRANSPORT

Newborn emergency transportation system, complete with inner fixing belts. Grants a warm, protected and safe environment. 3 transparent sides allowing complete and continuous monitoring of newborn by medical personnel.



INNER FIXING BELTS

Nuova versione PLUS completa di cinghie interne per il fissaggio del paziente. Materasso interno per un trasporto confortevole. Realizzazione a borsa ripiegabile che permette di essere agevolmente richiusa e trasportata.



ANCHORAGE TO THE STRETCHER

2 external handles for transportation. Arranged for the anchorage to the ambulance stretcher. Dimensions open: cm 90x38x34,5(h)
Dimensions closed: cm 90x38x15(h)
Supplied with transport bag.

RESCUE STRETCHER

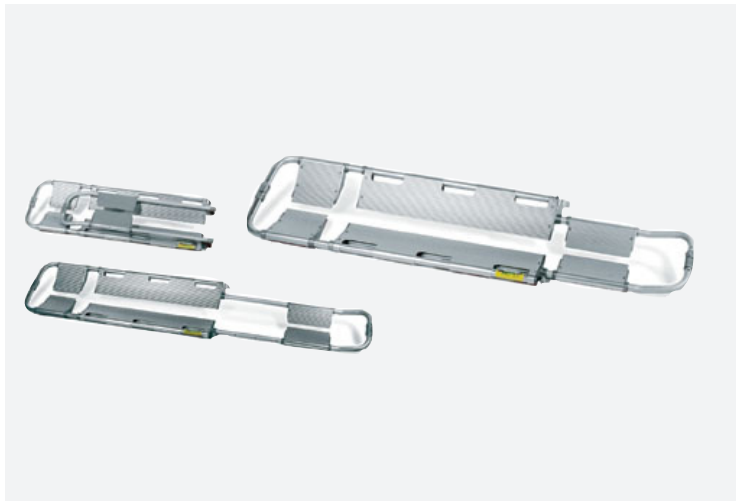

SCOOP STRETCHER - 630

Aluminium scoop stretcher. X-ray translucent. Effective hook/unhook device for stretcher parting. Adjustable length with automatic block. Bag with n. 3 quick unhook safety belts for patient immobilization. Capacity: about 170 kg. Weight: about 10 kg. Height: about 7 cm. Width: about 43 cm. Minimum Length: about 167 cm.

630 - SCOOP STRETCHER
614 - HORIZONTAL STIRRUPS
616 - VERTICAL STIRRUPS



RESCUE STRETCHER TOBOGA - 16100

Rescue stretcher, extremely lightweight, suitable for patient transport in uncomfortable environment conditions. Made in polymeric ABS material with aluminium frame. Complete of expanded polyurethane mattress and adjustable footrest. 4 quick unhook security belts. 12 transport handles. Arranged for the anchorage to helicopters. Dimensions: about 216x61x17h cm. Weight: 15 kg. Capacity: max 300 kg.

16100 - RESCUE STRETCHER TOBOGA
16100-005 - LIFTING HARNESS
16100-002 - FLOTATING SYSTEM

BARELLE DI SOCCORSO



EMERGENCY STRETCHER X1

Emergency stretcher made of lightweight aluminium. Foldable in length with safety blocks on use position. Made in resistant fireproof, tearproof and washable material with central reinforce. Complete with 2 automatic unhook safety belts. Removable handles in plastic non-sliding material. Available with feet and wheels.

Dimensions (opened): 230x55,6x13,7 cm.

Dimensions (closed): 192x15x14,5 cm.

Weight: about 9 kg.

IMM121532 - X1 WITH 4 FEETS

IMM121534 - X1 WITH 4 WHEELS

IMM121530 - X1 WITH 2 FEETS AND 2 WHEELS



EMERGENCY STRETCHER X2

Emergency stretcher made of lightweight aluminium. Foldable in length and width with safety blocks on use position. Made in resistant fireproof, tearproof and washable material with central reinforce. Complete with 2 automatic unhook safety belts. Removable handles in plastic non-sliding material. Available with feet and wheels.

Dimensions (opened): 230x55,6x13,7 cm.

Dimensions (closed): 104x15x14,5 cm.

Weight: about 9 kg.

IMM121538 - X2 WITH 4 FEETS

IMM121540 - X2 WITH 4 WHEELS

IMM121536 - X2 WITH 2 FEETS AND 2 WHEELS



ANATOMIC PILLOW FOR STRETCHER - IMM122050

Anatomic pillow for stretcher. Made in antibacterial, fireproof, washable material. Completely thermo-welded.

Dimensions: about 40x27x7 cm.

Weight: about 300 g.



RESUSCITATOR BAGS

SILICONE RESUSCITATOR BAGS



ADULT

Transparent silicone manual resuscitator, autoclavable up to 121°C
Volume 1700 ml
Complete with 360° rotating connection patient's valve
Safety valve for overpressure regulation
Additional inlet for dynamometer
Peep valve inlet
Supplied with mask no. 5, reservoir and oxygen tube
CE certified in class IIa

1333124 - SILICONE
RESUSCITATOR ADULT SIZE



PEDIATRIC

Transparent silicone manual resuscitator, autoclavable up to 121°C
Volume 500 ml
Complete with 360° rotating connection patient's valve
Safety valve for overpressure regulation
Additional inlet for dynamometer
Peep valve inlet
Supplied with mask no. 3, reservoir and oxygen tube
CE certified in class IIa

1333122 - SILICONE
RESUSCITATOR PEDIATRIC SIZE

DISPOSABLE RUBBER RESUSCITATOR BAGS



ADULT

Adult non-autoclavable rubber resuscitator bag. Volume 1600 ml. Complete with 360° rotating connection patient's valve. Adjustable safety valve to limit the overpressure applied by the patient. To be disinfected in bactericide solution. CE certified in class IIa.

PAL32200 - ADULT RUBBER



PEDIATRIC

Pediatric non-autoclavable rubber resuscitator bag. Volume 500 ml. Complete with 360° rotating connection patient's valve. Adjustable safety valve to limit the overpressure applied by the patient. Complete version supplied with mask size 3 with reservoir and shockproof oxygen tube. Latex free. To be disinfected in bactericide solution. CE certified in class IIa.

PAL32210 - PEDIATRIC RUBBER
PAL34210 - PEDIATRIC RUBBER
ALL-IN-ONE
PAL34214 - PEDIATRIC RUBBER
COMPLETE ALL-IN-ONE

DISPOSABLE PVC RESUSCITATOR BAGS



ADULT

Disposable manual resuscitator
Made in PVC material
Volume 1700 ml
Complete with 360° rotating
connection patient's valve
Safety valve for overpressure
regulation
Supplied with mask size 5 with
reservoir and oxygen tube
CE certified in class IIa

1331324 - PVC MANUAL
RESUSCITATOR ADULT SIZE



PEDIATRIC

Disposable manual resuscitator
Made in PVC material
Volume 500 ml
Complete with 360° rotating
connection patient's valve
Safety valve for overpressure
regulation
Supplied with mask size 3 with
reservoir and oxygen tube
CE certified in class IIa

1331322 - PVC MANUAL
RESUSCITATOR PEDIATRIC SIZE



INFANT

Disposable manual resuscitator
Made in PVC material
Volume 320 ml
Complete with 360° rotating
connection patient's valve
Safety valve for overpressure
regulation
Supplied with mask size 1 with
reservoir and oxygen tube
CE certified in class IIa

1331321 - PVC MANUAL
RESUSCITATOR INFANT SIZE

VENTILATION MASKS



SILICON MASKS

Transparent ventilation mask with silicone autoclavable lip-board ensuring maximum adherence to the face. The transparent shell allows patient's monitoring during ventilation.

-
- 1210602 - SILICONE MASK SIZE 2
 - 1210603 - SILICONE MASK SIZE 3
 - 1210604 - SILICONE MASK SIZE 4
 - 1210605 - SILICONE MASK SIZE 5
-



AIR CUSHION MASKS

Disposable ventilation mask
Shell shaped transparent plastic material
with air cushion border

-
- 1210230 - AIR CUSHION MASK SIZE 0
 - 1210231 - AIR CUSHION MASK SIZE 1
 - 1210232 - AIR CUSHION MASK SIZE 2
 - 1210233 - AIR CUSHION MASK SIZE 3
 - 1210234 - AIR CUSHION MASK SIZE 4
 - 1210235 - AIR CUSHION MASK SIZE 5
-

VENTILATION MASKS



DISPOSABLE RESERVOIR WITH INTEGRATED

Disposable reservoir for resuscitator bags OB with integrated valve.

PAL34350 - 2500 ml
PAL34356 - 900 ml



DISPOSABLE FILTER - 3505879

Disposable filter for resuscitator bags and automatic respirators. Sterile package.

VENTILATION SETS



REANIMATION BAG

Reanimation bag with shoulder strap for transport, featuring: resuscitator bag with turning connection security valve, 2 ventilation masks, reservoir, connecting tube for oxygen, 5 Guedel airways.

Dimensions: about 28x15x16 cm.

Weight: about 1 kg.

VAL40910 - REANIMATION BAG - SILICONE

VAL40916 - REANIMATION BAG - PVC



RESUSCITATION CASE SILICONE OB - VAL40902

ABS resuscitation case with wall anchorage system. 1 autoclavable silicone resuscitator bag. Reservoir and oxygen tube. 3 silicone transparent ventilation masks. 5 Guedel airways. Dimensions: 39,5x13,5x26(h) cm. Weight: about 2,3 kg.

VAL40902 - SILICONE RESUSCITATION CASE

VAL40904 - RUBBER RESUSCITATION CASE

VAL40905 - PVC RESUSCITATION CASE



PEDIATRIC/NEWBORN RESUSCITATOR BAGS SET

Set of 2 PVC disposable resuscitator bags featuring: 1 newborn resuscitator bag 240ml capacity. 1 pediatric resuscitator bag 500ml capacity. 2 ventilation masks. 1 reservoir + 1 oxygen tube. 3 Guedel airways

Dimension: about 25x25x8(h) cm

VAL44281 - PVC PEDIATRIC/NEWBORN

RESUSCITATION BAG



RELIABILITY

Diagnostic devices selected from the best manufacturers available on the market. All the devices we market are scrupulously checked according to documented procedures to guarantee quality and reliability.

STETHOSCOPES



SINGLE HEAD STETHOSCOPE

Traditional line in aluminium, lightweight and latex-free. Brass headset and anti-shiver chestpiece. Class I medical device in accordance with MDR 2017/745

32560 - STETHO TRAD BLACK
32561 - STETHO TRAD RED
32562 - STETHO TRAD BLUE
32563 - STETHO TRAD YELLOW
32564 - STETHO TRAD PURPLE



PEDIATRIC STETHOSCOPE

Traditional line in aluminium, lightweight and latex-free. Brass headset and anti-shiver chestpiece. Paediatric. Class I medical device in accordance with MDR 2017/745

32557 - PEDIATRIC STETHO TRAD PINK
32557 - PEDIATRIC STETHO LIGHT BLUE



SINGLE HEAD DELUXE STETHOSCOPE - HS-30N

Professional stethoscope. High sensibility. Silver head. Accurately perfected. Excellent sound transmission. Lightweight



DUAL HEAD STETHOSCOPE

Traditional line in aluminium, lightweight and latex-free. Brass headset and anti-shiver chestpiece. Class I medical device in accordance with MDR 2017/745

32565 - STETHO TRAD DUAL HEAD BLACK
32566 - STETHO TRAD DUAL HEAD RED

SPHYGMOMANOMETERS



ANEROID SPHYGMOMANOMETER - HS2000

Standard aneroid sphygmomanometer
Pressure gauge with graduated scale up to 300 mm/Hg. Distinctive colours of the dial: red and black. Red, for immediate recognition of hypo/hypertension states
Blue nylon cuff with Velcro closing.
Separate inflation bulb with fine pressure regulation valve. Supplied with transport and protective case. It is a CE medical device.
Measurements are to be carried out by qualified healthcare professionals



HANDHELD SPHYGMOMANOMETER - HS201C1

Hand-held sphygmomanometer with black cuff
Large pressure gauge with graduated scale up to 300 mm/Hg
Nylon cuff with Velcro closing for rapid use
Inflation bulb with pressure regulation valve
Measuring accuracy: ± 3 mmHg
Supplied with transport case

SPHYGMOMANOMETERS



SPHYGMOMANOMETER PROFESS. I - HS-201Q1

Professional 1 tube sphygmomanometer
Big manometer with scale up to 300 mm/Hg
(70 mm diameter). Cuff with Velcro closing
Deflation valve with screw regulator or rapid
deflation button. Turning manometer that
allows the use to both left- and right-handed
users. Practical protection and transport
case. Is a medical device CE. The device
can be used by trained personnel only or
doctors.



SPHYGMOMANOMETER WITH STETHOSCOPE - 32693

KIT YTON consisting of sphygmomanometer
and stethoscope. Classic
Sphygmomanometer with nylon cuff, Velcro
fastener, latex pear with chrome valve
and detachable manometer which can be
attached to the cuff. Chromium-plated air
valve with air release control via screw valve.
Scale graduated every 2 mmHg, from 0 to
300 mmHg. Manual control of air release
possible from 260 mmHg to 15 mmHg.
Deflation time max. 10 sec. Floating zero
(pointer does not have a stop point but
oscillates freely). Supplied with a soft
leatherette bag with zip, in a cardboard box.
Colour: black
Class Im medical device in compliance
with Directive 93/42/EEC and subsequent
amendments and supplements

SPHYGMOMANOMETERS



AUTOMATIC/DIGITAL SPHYGMOMANOMETER- LD-588

52x59 mm LCD display. Up to 60 measurements storage capacity. Oscillometric measurement method. Pressure measurement scale: 40-260 mm/Hg. Pulse measurement scale: 40-160 beats/min. Accuracy: ± 3 mm/Hg (pressure) $\pm 5\%$ (pulse). Automatic pressurization. Quick depressurization with valve. Power supply: 4 x 1.5V AA batteries (not included). Dimensions: 127x99x50 mm. Weight: approx. 255 g without batteries. It is a CE medical device. Measurements are to be carried out by qualified healthcare professionals.



TABLE ANEROID SPHYGMOMANOMETER - DIA2009

Circular wall and/or table aneroid sphygmomanometer (diameter 170mm). Scale from 0 to 300 mm/Hg. Velcro-closing cuff and inflation bulb, spiral connecting tube. Wall anchor support with basket bracelet holder. Risk class I m, according to directive MDD 93/42/CEE. The device complies with the REACH regulation in force.

OMRON SPHYGMOMANOMETERS



OMRON M2 SPHYGMOMANOMETER - OMM2EC

Digital Automatic Blood Pressure Monitor. Compact, fully automatic, user-friendly and quick. Measures blood pressure and pulse rate. “IntelliSense” technology for comfortable controlled inflation. Detects irregular heartbeats. Memory for 30 sets. Digital LCD display. Power source: 4 AA batteries 1,5 V (included).



OMRON M3 SPHYGMOMANOMETER - OMM3IWIN

Digital arm blood pressure monitor. Compact, fully automatic, simple and fast. Comfortable controlled inflation with “Intelli Sense” technology. Precise measurement with “Intelli Wrap” comfort cuff. Indicator of correct armband positioning. Movement indicator. Detection of irregular heartbeats. Display of the average value of the last 3 measurements. Memory capacity of 60 measurements with date and time for each user (1 and 2). Power supply: 4 AA batteries (included). Class IIa medical device in compliance with MDD/93/42/EEC Directive.



OMRON M7 INTELLI IT SPHYGMOMANOMETER - OMM7ITIN

Digital arm blood pressure monitor. Compact, fully automatic, simple and fast. Automatic inflation through electric pump. Detection of irregular heartbeats. Memory capacity of 100 measurements per user. Digital LCD display. Power supply: 4 AA batteries (included) or mains adapter optionally. Class IIa medical device in compliance with MDD/93/42/EEC Directive as amended.

PULSISSIMETRI



ADULT FINGER PULSE OXIMETER - FS20C-NS

Device for measuring blood oxygen saturation. Compact and lightweight, equipped with colour LED display. Detects oxygen saturation (SpO₂) and pulse rate. Battery level indicator. Without acoustic alarms. Provided with 2 AAA batteries. Dimensions: about 58x33x36mm. Maximum weight: 60g (with batteries). Class IIb CE medical device (93/42/CEE).

FS20C-NS - ADULT FINGER PULSE OXIMETER
FS-01 - CASE FOR FINGER OXIMETER



HANDHELD PULSE OXIMETER - HS10A

Lightweight for carrying and Easy-To-Use. Silicon rubber shell protection and stable metal bracket for table usage. Adult, pediatric and neonate oximeter probe available. CE medical device. Isolation class: II. Protection against electric shock: type BF – applied part. Protection against the penetration of fluids and substances: IPX1. Visual and acoustic alarm available. Big size 2.4" LCD display with SPO₂, pulse ratio, pulse bar-graph and plethysmogram. SPO₂ resolution 1 %. Low Battery voltage indicator. Refreshing rate: 1 sec. The unit can work with alkaline batteries (2000 mAh) or rechargeable Lion battery pack (1600 mAh).

HS10A - HANDHELD PULSE OXIMETER

DIAGNOSTIC PENLIGHTS



OB DIAGNOSTIC PENLIGHT - HS-40 1F

Rechargeable diagnostic bright penlight. Built in plastic material. Pocket clip. Complete with batteries AAA. Supplied in single package



DIAGNOSTIC PENLIGHT WITH LED - DIA 10 10 12

Rechargeable diagnostic bright penlight with LED light. Built in metal material. Pocket clip. Complete with 2 batteries AAA.

THERMOMETERS



INFRARED DIGITAL THERMOMETER - FT100B

LCD display with 3½ figures. Temperature unit of measurement: Celsius degrees (°C) and Fahrenheit (°F). Measurement range: 32.0 – 42.9 °C. Saves last 10 performed measurements. Powered by not rechargeable battery, PC 2032 type (1pc). The batteries last about 2500 uses. Size: 105x35x35mm. Net weight: 36gr. Acoustic alarm: beep sound for ON-OFF. Complete with protective plastic case.



DIGITAL THERMOMETER - RM300

Measurement of body temperature by oral, axillary or rectal contact. Measurement in 60 seconds. Units of measurement in degrees Celsius (°C) and Fahrenheit (°F). Sensed temperature range: 32°C to 42.9°C. LCD display with 3 displayed digits. Water resistant tip (IP27 degree of protection). 1.5 V alkaline battery. Autonomy of approx. 200 hours. Keeps track of the last measurement. Class IIa EC medical device in compliance with MDD/93/42/EEC and subsequent amendments and additions.



MERCURY FREE THERMOMETER- TER174

Clinical mercury-free thermometer for body temperature detection. The liquid used is a “Gallio/Indio” alloy combination, totally non-toxic and safe for the environment. CE medical device. Detection range: 35-42° C, precision: 0,10° C
Dimensions: about 125x12x8 mm.

DIAGNOSTICS DEVICES AND ACCESSORIES



PRESSURE INFUSER WITH OB MANOMETER - DIA 100390

Pressure infuser for medicaments contained in plastic material sachets. Complete with manometer for infusion monitoring and mono-ball with deflating valve for accurate dosage. Suitable for 500 ml infusion. CE medical device.



BLACK OPHTHALMOSCOPE - DIA 100415

Fiber optic 2,5V bulb. Ophthalmoscope: head with screw blocking; corrective lenses from 0 to +20 and 0 to -20 dioptres with 5 different diaphragm apertures. Plastic/metal handle with batteries; working with 2 batteries type AA (not included). Complete with shockproof plastic case. CE medical device.



MINI OTOSCOPE WITH CONVENTIONAL LIGHT - DMV520

High quality blue otoscope for pocket and doctor's bag. Unobstructed view, unit equipped with halogen bulb. Robust and light weight plastic with metal inserts and 3x rotating magnifying glass. Handle requires 2 batteries (AA) and it is equipped with grooves for a better grip. Speculum input is rapid and stable. Provided with bag and with 4 additional reusable specula.

DIAGNOSTICS DEVICES AND ACCESSORIES



ECG ELECTRODES

E.C.G. electrodes. Base made of foam material. Conductive paste. Optimal detection of the tracing.

Adult: diameter 55 mm.

Pediatric: diameter 43 mm.

50 pcs package.

F9060 - ADULT ECG ELECTRODES 50 pcs

F9060P - PEDIATRIC ECG ELECTRODES 50 pcs



ADULT PADS - F7956W

PADs for adults.

Suitable for defibrillator OB Life Support 300. PADs with blue connector should be used for patients, whose weight is more than 25 kg.

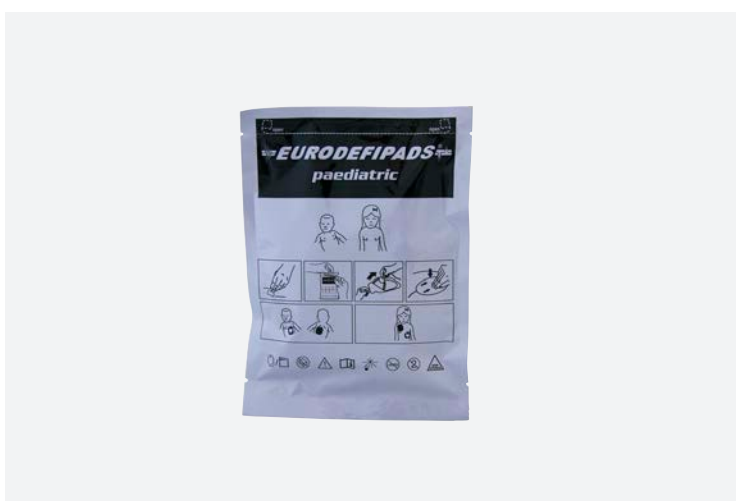

PEDIATRIC PADS - F7956P

PADs for children.

Suitable for defibrillator OB Life Support 300. PADs with yellow connector should be used for children, whose weight is less than 25 kg (younger than 8 years of age).



REANIMATION

We have a range of products for the most critical situations: medical devices for reanimation and specific kits. Our goal of guaranteeing reliability and safety for patients and users is achieved through constant quality controls.

CONVENTIONAL LIGHT LARYNGOSCOPE



MC-INTOSH LARYNGOSCOPE

Mc Intosh blades for conventional light laryngoscope, made in steel. Different sizes available. Sets with autoclavable laryngoscope available with 3 blades (sizes from 1 to 3) or 4 blades (sizes from 0 to 3). Sets are supplied with a practical roll case.

RIA53000 - 3 BLADES SET MC-INTOSH CONVENTIONAL LIGHT
RIA53004 - 4 BLADES SET MC-INTOSH CONVENTIONAL LIGHT
RIA53020 - MC-INTOSH CONVENTIONAL LIGHT BLADE SIZE 0
RIA53022 - MC-INTOSH CONVENTIONAL LIGHT BLADE SIZE 1
RIA53024 - MC-INTOSH CONVENTIONAL LIGHT BLADE SIZE 2
RIA53026 - MC-INTOSH CONVENTIONAL LIGHT BLADE SIZE 3
RIA53028 - MC-INTOSH CONVENTIONAL LIGHT BLADE SIZE 4



MILLER LARYNGOSCOPE

Conventional light metal autoclavable laryngoscope with straight Miller blades in steel for conventional light laryngoscope. Blades are available in different sizes. Available in set with 3 blades (sizes from 0 to 2) and a practical roll case.

RIA53100 - 3 BLADES SET MILLER CONVENTIONAL LIGHT
RIA53120 - MILLER CONVENTIONAL LIGHT BLADE SIZE 0
RIA53122 - MILLER CONVENTIONAL LIGHT BLADE SIZE 1
RIA53124 - MILLER CONVENTIONAL LIGHT BLADE SIZE 2
RIA53126 - MILLER CONVENTIONAL LIGHT BLADE SIZE 3
RIA53128 - MILLER CONVENTIONAL LIGHT BLADE SIZE 4

FIBER OPTIC LARYNGOSCOPE



MC-INTOSH LARYNGOSCOPE

Mc Intosh fiber optic blades made in steel for fiber optic laryngoscope. Different sizes available. 2,5V halogen lamp set inside the blade for an easy sterilization. Sets with laryngoscope available with 3 blades (sizes from 1 to 3) or 4 blades (sizes from 0 to 3). Sets are supplied with a practical roll case.

RIA53200 - 3 BLADES SET MC-INTOSH FIBER OPTIC
RIA53204 - 4 BLADES SET MC-INTOSH FIBER OPTIC
RIA53220 - BLADE MC-INTOSH FIBER OPTIC SIZE 0
RIA53222 - BLADE MC-INTOSH FIBER OPTIC SIZE 1
RIA53224 - BLADE MC-INTOSH FIBER OPTIC SIZE 2
RIA53226 - BLADE MC-INTOSH FIBER OPTIC SIZE 3
RIA53228 - BLADE MC-INTOSH FIBER OPTIC SIZE 4
RIA53230 - BLADE MC-INTOSH FIBER OPTIC SIZE 5



MILLER LARYNGOSCOPE

Miller fiber optic blades made in steel for fiber optic laryngoscope. Different sizes available. 2,5V halogen lamp set inside the blade for an easy sterilization. Sets with laryngoscope available with 2 blades (sizes from 0 to 1) or 3 blades (sizes from 0 to 2). Sets are supplied with a practical roll case.

RIA53300 - 2 BLADES SET MILLER FIBER OPTIC
RIA53304 - 3 BLADES SET MILLER FIBER OPTIC
RIA53320 - BLADE MILLER FIBER OPTIC SIZE 0
RIA53322 - BLADE MILLER FIBER OPTIC SIZE 1
RIA53324 - BLADE MILLER FIBER OPTIC SIZE 2
RIA53326 - BLADE MILLER FIBER OPTIC SIZE 3

FIBER OPTIC LARYNGOSCOPE WITH DISPOSABLE BLADES



MC-INTOSH DISPOSABLE BLADES

Disposable fiber optic Mc Intosh laryngoscope blade, made in plastic material. Different sizes available.

Size 1: 92x15(h)

Size 2: 112x15(h)

Size 3: 132x25(h)

Size 4: 165x30(h)

RIA53444 - DISPOSABLE MC INTOSH BLADE SIZE 1
RIA53446 - DISPOSABLE MC INTOSH BLADE SIZE 2
RIA53448 - DISPOSABLE MC INTOSH BLADE SIZE 3
RIA53450 - DISPOSABLE MC INTOSH BLADE SIZE 4



MILLER DISPOSABLE BLADES

Disposable fiber optic Miller laryngoscope blade, made in plastic material. Different sizes available.

Size 0: 75x8(h)

Size 1: 100x8(h)

Size 2: 132x9(h)

Size 3: 172x12(h)

RIA53432 - DISPOSABLE MILLER BLADE SIZE 0
RIA53434 - DISPOSABLE MILLER BLADE SIZE 1
RIA53436 - DISPOSABLE MILLER BLADE SIZE 2
RIA53438 - DISPOSABLE MILLER BLADE SIZE 3

LARYNGOSCOPE ACCESSORIES



CONVENT. LIGHT LARYNG. HANDLE

Conventional light laryngoscope handle made in stainless steel.
Dimensions: Ø 30x148 mm.

RIA53030 - CL L. HANDLE
RIA53182 - CL L. BLADE BULB



FIBER OPTIC LARYNG. HANDLE

Fiber optic laryngoscope handle made in stainless steel.
Dimensions: Ø 30x152 mm.

RIA53232 - FO L. HANDLE
RIA53380 - FO L. BLADE BULB



SMALL CONVENT. LIGHT LAR. HANDLE

Small conventional light laryngoscope handle made in stainless steel.
Dimensions: Ø 20x155 mm.

RIA53130 - SMALL CL L. HANDLE
RIA53180 - CL L. SMALL BLADE BULB



SMALL FIBER OPTIC LARYNG. HANDLE

Small fiber optic laryngoscope handle made in stainless steel.
Dimensions: Ø 20x152 mm.

RIA53330 - SMALL FO L. HANDLE
RIA53382 - FO L. SMALL BLADE BULB



ROLL-CASE FOR LARYNGOSCHOPE

Roll-case for laryngoschope - red. 5 inner compartments.
Made in washable cloth with inner stuffing.
Dimensions : about 19x34 cm.

BOR84041 - ROLL CASE FOR LARYNGOSCHOPE

AIRWAYS AND CATHETER MOUNT



GUEDEL AIRWAY NO. 000

Pink - 4 cm
Ref.: 5100



GUEDEL AIRWAY NO. 00

Blue - 5 cm
Ref.: 5010



GUEDEL AIRWAY NO. 0

Black - 6 cm
Ref.: 5000



GUEDEL AIRWAY NO. 1

White - 7 cm
Ref.: 5001



GUEDEL AIRWAY NO. 2

Green - 8 cm
Ref.: 5002



GUEDEL AIRWAY NO. 3

Yellow - 9 cm
Ref.: 5003



GUEDEL AIRWAY NO. 4

Red - 10 cm
Ref.: 5004



GUEDEL AIRWAY NO. 5

Light blue - 11 cm
Ref.: 5005

RIA50290 - SET OF 5 GUEDEL AIRWAYS
(0/1/2/3/4)



WENDL AIRWAY

Wendl nasopharyngeal airway, with ending pipe ring. Supplied singularly in sterile package. Different sizes available.

185420-000260 - WENDL AIRWAY CH 26-8,7 mm
185420-000280 - WENDL AIRWAY CH 28-9,3 mm
185420-000300 - WENDL AIRWAY CH 30-10 mm



CATHETER MOUNT - 1515TG

Catheter Mount, lightweight, transparent, disposable and at low compliance. Supplied with perfect capacity connectors. Extremely flexible. Allows up to 360° angulation without any modification to inside volume, crushproof. Connectors in compliance to ISO norms. Dimensions: 20 cm.

REANIMATION DEVICES



STERILE ENDOTRACHEAL TUBES

Cuffed endotracheal tubes in plastic material. Unidirectional valve, standard connector in accordance to ISO norms. Reference notches, x-ray opaque, non-traumatic tip. Supplied in sterile package. Different sizes available.

11814102003 - CH12 3,0MM
11814102004 - CH14 3,5MM
11814102005 - CH16 4,0MM
11814102006 - CH18 4,5MM
11814102007 - CH20 5,0MM
11814102008 - CH22 5,5MM
11814102009 - CH24 6,0MM
11814102010 - CH26 6,5MM
11814102011 - CH28 7,0MM
11814102012 - CH30 7,5MM
11814102013 - CH32 8,0MM
11814102014 - CH34 8,5MM



THOMAS HOLDER

Safety endotracheal tubes blocking system. Screw system, integrating a no-lockjaw surface which protects teeth and gums and avoids endotracheal tube crushing. It avoids use of plaster.

05-1650 - ADULT THOMAS HOLDER
05-1651 - PEDIATRIC THOMAS HOLDER

REANIMATION DEVICES



LIFE KEY MASK KEY-RING

Key-ring with mouth to mouth ventilation mask. Elastics for ear fixing. One way valve for a safe ventilation. Singularly packaged . Non-sterile.

FS-102B - LIFE KEY MASK KEYRING RED
FS-102 - LIFE KEY MASK



QUICKTRACH

Urgent coniotomy sterile set quicktrach type. Complete with 1 plastic canula with intubation internal-blade stylet with diameter of 4 mm for adults and 2 mm for child. Complete with ISO joint for the connection to resuscitation bag. Quicktrach features a sharp conical-tip intubation stylet that avoids windpipe incision using classic scalpel and a "lock" that avoids to penetrate too much in depth. 2 lateral wings allowing airways safe fixing.

VBM30-04-0021 - CHILD QUICKTRACH
VBM30-04-0041 - ADULT QUICKTRACH



INTUBATION STYLETS

Flexible and coated intubation stylets. Different sizes available.

RIA52213 - INTUBATION STYLET FR6 - 2,0 MM
RIA52214 - INTUBATION STYLET FR10 - 3,3 MM
RIA52215 - INTUBATION STYLET FR14 - 4,7 MM

SET DI INTUBAZIONE - LUCE CONVENZIONALE



INTUBATION BAG COMPLETE - RIA50820

Intubation bag complete of: 1 conventional light laryngoscope with 3 blades (1-2-3), 1 Magill forceps, 1 Pean forceps, 1 scissors, 5 endotracheal tubes, 3 Guedel airways, 1 syringe, 1 mouth opener, 1 plaster roll, 2 Wendl airways, 1 stylet.

Dimensions: about 32x22x7,5(h) cm.

Weight: 1,2 kg.



PEDIATRIC INTUBATION BAG COMPLETE - RIA50816

Intubation bag complete of: 1 pediatric conventional light laryngoscope with 3 blades (0-1-2), 1 Magill forceps, 1 Pean forceps, 1 scissors, 4 endotracheal tubes, 3 Guedel airways, 1 syringe, 1 mouth opener, 1 plaster roll, 2 Wendl airways, 1 stylet.

Dimensions: about 32x22x7,5(h) cm.

Weight: 1 kg.



INTUBATION SET IN POUCH - VAL44410

Complete intubation set in pouch with transparent frontal, featuring: 1 laryngoscope pediatric handle, 1 C.L. Mc Intosh blade size 0, 1 C.L. Miller blade size 1, 1 C.L. Miller blade size 0, 1 Magill forceps, size 16, 1 Pean forceps, 4 endotracheal tubes, 4 Guedel airways sizes 000/00/0/1, 1 intubation stylet, 1 plaster roll.

Dimensions: about 27x12x9(h) cm.

Weight: 600 g.



PEDIATRIC INTUBATION SET IN POUCH - VAL44390

Complete intubation set in pouch with transparent frontal, featuring: 1 laryngoscope with 3 conventional light blades, 1 Magill forceps, 1 Pean forceps, 1 scissors, 5 endotracheal tubes, 3 Guedel airways, 1 syringe, 1 mouth opener, 1 plaster roll, 2 Wendl airways, 1 Intubation stylet.

Dimensions: about 27x12x9h cm.

Weight: 1kg.

SET DI INTUBAZIONE - FIBRE OTTICHE



INTUBATION BAG COMPLETE - RIA50822

Intubation bag complete of: 1 fiber optic laryngoscope with 3 blades (1-2-3), 1 Magill forceps, 1 Pean forceps, 1 scissors, 5 endotracheal tubes, 3 Guedel airways, 1 syringe, 1 mouth opener, 1 plaster roll, 2 Wendl airways, 1 stylet.

Dimensions: about 32x22x7,5(h) cm.

Weight: 1,3 kg.



PEDIATRIC INTUBATION BAG COMPLETE - RIA50825

Intubation bag complete of: 1 fiber optic laryngoscope with 3 blades (0-1-2), 1 Magill forceps, 1 Pean forceps, 1 scissors, 4 endotracheal tubes, 3 Guedel airways, 1 syringe, 1 mouth opener, 1 plaster roll, 2 Wendl airways, 1 stylet.

Dimensions: about 32x22x7,5(h) cm.

Weight: 1 kg.



DISPOSABLE INTUBATION BAG COMPLETE- RIA50826

Intubation bag complete of: 1 fiber optic laryngoscope with 6 blades, 1 Magill forceps, 1 Pean forceps, 1 scissors, 5 endotracheal tubes, 3 Guedel airways, 1 syringe, 1 mouth opener, 1 plaster roll, 2 Wendl airways, 1 stylet.

Dimensions: about 32x22x7,5(h) cm.

Weight: 1kg.



SURGICAL MEDICATION AND INSTRUMENTS

We distribute surgical medication and instruments that are subjected to quality controls before being placed on the market.

SPECIFIC MEDICATION KITS

We create specific kits to deal with emergencies of various entities and nature, for domestic, non-professional and professional use.

FIRST AID CASES

We provide first aid boxes that meet the requirements of workplace safety.

GAUZE COMPRESSES



STERILE COTTON GAUZE 8 FOLDES 10X10- 401725

Sterile cotton medication gauze compresses, two 8-ply 10x10 compresses Indicated for emergency and first aid activities



NON WOVEN STERILE GAUZE 6 LAYERS 10X10 - 411077



STERILE GAUZE COMPRESS 18X40 - 30GCS1840



NON-STERILE GAUZE COMPRESSES – 100PCS

12-layer, non-sterile gauze compresses made of pure cotton. Package: 100 pcs. Different sizes available.

-
- 61050 - 100 pcs 5x5 cm
 - 61051 - 100 pcs 7,5x7,5 cm
 - 61052 - 100 pcs 10x10 cm
-



1 KG NON-STERILE GAUZE COMPRESS

Non-sterile medication gauze, pure cotton. 1 kg package. Different sizes available.

-
- 61610 - 1 kg GAUZE 10x10 cm
 - 61645 - 1 kg GAUZE 15x15 cm
 - 61670 - 1 kg GAUZE 20x20 cm
 - 61710 - 1 kg GAUZE 30x30 cm
-

ELASTIC TUBULAR NET, BANDAGES AND COTTON

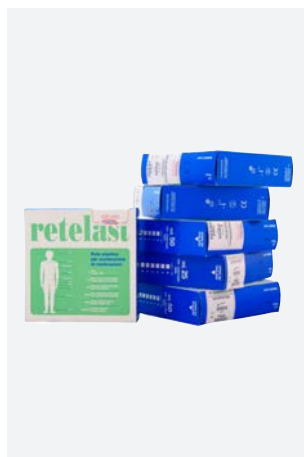

ELASTIC TUBULAR NET

Elastic tubular net for medications on every body's part. Easy and quick application.

75412 - SIZE 1 - 50 m
75414 - SIZE 2 - 50 m
75416 - SIZE 3 - 50 m
75418 - SIZE 4 - 50 m
75420 - SIZE 5 - 50 m
75422 - SIZE 6 - 25 m



ELASTIC TUBULAR NET

Elastic tubular net for medications. Easy and quick application. Length: about 40cm. The size is indicated for hand, wrist, foot, ankle.

75466 - ELASTIC TUBULAR NET MEDIUM



COTTON

Absorbent cotton wool 20 or 50 g package. Not a medical device.

COT104 - COTTON 50 g
COT279 - COTTON 20 g



EDGED BANDAGE

Flexible medication bandage. Singularly packaged in sealed wrapping. Different sizes available.

30BI0405 - BANDAGE 5 cm
30BI0410 - BANDAGE 10 cm
30BI0408 - BANDAGE 8 cm



COHESIVE BANDAGE

Self-fixing elastic bandage, lightweight and soft. Self adherent thanks to its atural rubber latex micro particles. Does not adhere to the skin and it is highly transpiring. Different sizes available, lenght 4 m.

370 - BENDA COESIVA 4 cm
371 - BENDA COESIVA 6 cm
372 - BENDA COESIVA 8 cm
373 - BENDA COESIVA 10 cm

PLASTERS



CLOTH PLASTER ROLL - 400014

Adhesive cloth roll. Class I non-sterile medical device in compliance with Directive 93/42/EEC. Single pack.



ASSORTED PLASTERS - 400187

Breathable sterile classic plaster assorted in 4 different sizes. Class Is medical device in compliance with Directive 93/42/EEC. Package of 10 pieces. Singularly packaged.



SKIN SAVER - MED97049

Thin and light layer made of polyurethane foam. Apply before bandaging. Dimensions: cm 7x27,5 m.



ELASTICATED STRIP PLASTER

Medicated strip plaster in elasticated cotton material, with transpiring gauze pad. Available in two dimensions for a width of 6 cm.

70051 - STRIP PLASTER 1 m
70054 - STRIP PLASTER 5 m



POLYETHYLENE STRIP PLASTER - 70104

Skin coloured polyethylene medicated strip plaster. Waterproof, elastic, transpiring and hypoallergenic. High absorbing viscous gauze pad, does not stick to the wound. Dimensions: 5 m x6 cm. Singularly packaged.



EXTRA LONG 50PCS BLUE DETECTABLE DRESSING - CER143

The dressing length helps you to wrap your finger more than once, protecting the eventual cut or graze and avoiding accidental detachments, as it may happen for the smaller dressings. Dimensions: 18x2 cm. Pack of 50pcs.

PLASTERS



PLASTER FOR LINE-IN CANNULA NEEDLE - 35CER400

Non-woven plaster used to fasten and secure cannula needles. One package, 50 pcs. Size: 9x6 cm.



OMNISTRIP SUTURE PLASTER - 540684

Sterile suture plaster skin colour, coated with an hypoallergenic adhesive layer. Suitable for small wound non-traumatic closing. 10 sterile strips.



ADHESIVE STERILE EYE BANDAGE - 35CER314

Sterile medication ocular compress with a high absorbent power on adhesive support. Hypoallergenic and transpiring. For secure and comfortable application on the eye.

IMMOBILIZATION AND MEDICATION SHEET



NON-WOVEN IMMOBILIZATION CLOTH - 62100

Triangular immobilization sheet, made of non-woven fabric, singularly packaged. Size: about 96x96x136 cm



STERILE MEDICATION CLOTH

Sterile medication cloth, ready to use for physiological treatment of wounds and burns. Hypoallergenic, transpiring with high. Absorbing capability. Allows transpiration of wound or burn and absorbs without sticking. Provided in a single sterile wrap.

-
- 62050 - STERIL CLOTH 40x60 cm
 - 62051 - STERIL CLOTH 60x80 cm
 - 62052 - STERIL CLOTH 80x120 cm
-



HEMOSTATIC BANDAGE PAD - 1002001

Compressive bandaging for wounds and haemorrhages. It assures wound hemostasis thanks to the compression performed by elastic bandage on the hemostatic pad. The pad assures the hemostasis and moreover does not allow blood leakage. Supplied in sterile package. Dimensions: about 300x10 cm.

MEDICATION PACKAGES



MEDICAL PACKAGE D.I.N.

Sterile dressing package according to norm DIN 13151. Ready to use bandage and gauze. Hypoallergenic and with great transpiration power. Highly absorbent. Sterile packaging, immediately ready to use. Bandage length: 4 m. Different sizes available.

-
- 62000 - DIN MEDICATION PACKAGE S - 6 cm
 - 62001 - DIN MEDICATION PACKAGE M - 8 cm
 - 62002 - DIN MEDICATION PACKAGE L - 10 cm
-



ALUMINIUM MEDICATION PACKAGES, ALUMINIUM COMPRESS AND ALUMINIUM CLOTHS

Sterile dressing for wounds and burns: aluminized medication package. Hypoallergenic, transpiring, anti-bacteria, highly absorbent and incohesive. Composed of a layer of aluminum and a layer of gauze with high absorbency that greatly reduces the infection. The aluminum film, in direct contact with the wound or with the burn, allows the transudate or blood to pass through with the aluminum layer not adhering to the wound. Promotes epithelialization and scar tissue formation. Thanks to the great absorbent power, but not adherent, it facilitates the change of the dressing.

-
- 63050 - ALUMINIUM MEDICATION PACKAGE S
 - 63051 - ALUMINIUM MEDICATION PACKAGE M
 - 63052 - ALUMINIUM MEDICATION PACKAGE G
 - 63003 - ALUMINIUM COMPRESS 10x10 cm
 - 63100 - ALUMINIUM CLOTH 40x60cm
 - 63101 - ALUMINIUM CLOTH 60x80 cm
-

DISPOSABLE GLOVES IN LATEX

STERILE LATEX GLOVES

Sterile, single-use surgical glove made of pure “medical grade” natural rubber latex, powder-free and with microrough surface. Opaque color and anti-reflective, single-body and smudge-free. Anatomical (right and left) with tear-protecting and anti-roll cuff that ensures optimal adherence even to scrubs. Gamma sterilized. Biocompatible and impervious to viral penetration. Tiourami-free. Class IIa medical device under Directive 93/42/EC and Cat. III PPE under EU Reg. 2016/425 1 pair of gloves (right and left) per pouch.

DPRO-PF-65 - SIZE 6,5
DPRO-PF-70 - SIZE 7,0
DPRO-PF-75 - SIZE 7,5
DPRO-PF-85 - SIZE 8,5

STERILE LATEX SIZE L

1 pair of disposable sterile latex gloves. Singularly packaged. Size: L.

01BML0S0G - STERILE
LATEX GLOVES SIZE L



TOURNIQUET



LATEX FREE

Quick release latex free tourniquet, one hand operated. Easy to use, ensuring an excellent hemostasis without skin and tissues laceration. Quick opening and progressive/adjustable haemostasis reduction.

MED98210 - RED
MED98212 - BLUE



CAT COMBAT APPLICATION TOURNIQUET - CAT-007

Original Cat Combat Application Tourniquet haemostatic tourniquet, in nylon material with micro metrics regulation.



FLAT TOURNIQUET - 500120

Flat tourniquet made of nitrile strip. Class I medical device according to Regulation 2017/745. Suitable for adult patients



3PCS FLAT TOURNIQUET - 500057

Set of 3 pcs flat nitrile tourniquets



LATEX FREE BABY - MED98208

Quick release latex free tourniquet, one hand operated. Easy to use, ensuring an excellent hemostasis without skin and tissues laceration. Quick opening and progressive/adjustable haemostasis reduction. Fantasy colour.

NEEDLES BOX



MULTI-SAFE MINI 300

Container suitable for needles and sharps. With safety locking system. Made of polypropylene. Volume: 0,3 L. Dimensions: 7,8x4,5x16 cm.

MED98609 - MULTI-SAFE MINI 300



MULTI-SAFE SANI 200

Container suitable for needles and sharps. With safety locking system. Made of polypropylene. Volume: 0,2 L. Dimensions: 7,3x4,5x13 cm.

MED98613 - MULTI-SAFE SANI 200



MULTI-SAFE VARIO 2000

Container suitable for needles and sharps. With safety locking system. Easy handling during lid assembly due to snap-on hooks. Clear fill level marking thanks to new label design. Compatible with standard trays. Made of polypropylene. Volume: 2,0 l. Dimensions: 95 x 240 x140 mm

MED98625 - MULTI-SAFE VARIO 2000



RIGIBOX EUROMATIC

Waste and needle box, specific for ambulances. With safety closure. Made of eco-friendly polypropylene with a red cap. Volume: 7 l. Size: about 17x17x 39 cm.

MED98631 - RIGIBOX EUROMATIC
MED98623 - WALL HOLDER FOR EUROMATIC

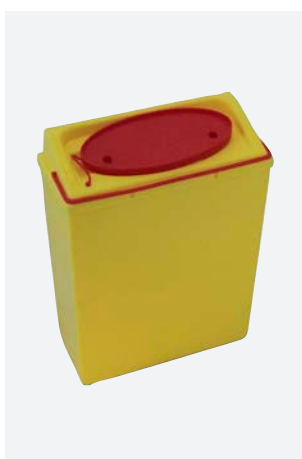

KONTAMED

Trash and needles box suitable for ambulance. Wall bracket for wall fixing. Complete of safety closure. Manufactured in yellow high resistant plastic material. Dimensions: about 170x75x225h mm.

2009067 - KONTAMED



KONTAMED MINI

Small trash and needles box suitable for emergency bags and cases. Complete of safety closure. Manufactured in yellow high resistant plastic material. Dimensions: 45x115h mm.

2009068 - KONTAMED MINI

SYRINGE AND NEEDLES

CANNULA NEEDLE



2 FEB ways intravenous catheter needle with pliable wings injection valve. Best convenient use, utmost fixing to the skin. Sterile, disposable, non-toxic, x-ray opacity, nonpyrogenic.

50AC2S14 - ORAN. 14-45 mm
50AC2S16 - GREY 16-45 mm
50AC2S18 - GREEN 18-45 mm
50AC2S20 - PINK 20-32 mm
50AC2S22 - L. BLUE 20-25 mm
50AC2S24 - YELL. 24-23 mm
35CER400 - PLASTER FOR
LINE-IN NEEDLE 50 PCS



BUTTERFLY NEEDLES

Sterile epicranial butterfly needle, for intravenous infusion. Indicated for patients with capillary fragility, for children, and in the case a thin atraumatic needle is needed. Easily flexible.

90185 - GREEN 21G
90187 - LIGHT BLUE 23 G

CUP CANNULA NEEDLE - 90227



Disposable sterile protective cap for needle canula.

3-WAY TAP - 90232



3-way tap with spinning luer lock.

STERILE SYRINGE



Sterile disposable syringes, singularly packaged.
1 Package, 100 pcs.

BH1511002MC - SYR. 2,5 cc
BH1511005MC - SYR. 5 cc
BH1511010MC - SYR. 10 cc
BH1511020MC - SYR. 20 cc

FLUIDS ADMINISTRATION SET - 01D193E2N



Infusion set for administration of solutions. (Not for blood or blood products). Sterile infusion set for delivery of liquids and fluids in intravenous therapy and medical application. With an antibacterial drip chambers, lines and tubing with roller clamp. Disposable with protective end caps and filter.

VISORS AND PROTECTION GLASSES



SURGICAL MASK WITH LACES AND VISOR - 02MFSE00-1

Disposable face mask made of four layers of non-woven fabric with anti-fog visor, adaptable nose clip. With elastic headband, colour green. Made of TNT (non-woven fabric) is seamless. The mask is non-toxic, hypoallergenic and odourless and offers very low breathing resistance. It has a high filtering capacity and contains no glass fibres, nickel or other harmful substances. Latex free.



RECLINING FACIAL PROTECTION SCREEN - L35101014

Personal protective equipment compliant with norm EN 166:2001. Reclining screen for face protection made of transparent polycarbonate. Adaptable to all head sizes thanks to a rear mechanical adjustment system. Effectively protects against liquids, particulates, and small mechanical impacts. Optic Class type 1. Thanks to the material with which it is made, the screen allows excellent visibility. The screen is reusable, and the front foam can be replaced by purchasing spare parts separately.



PROTECTION GLASSES - MED98704

Eye protection glasses.
Transparent lens and frames. Scratchproof lens.
Lateral protection on the bars. May be used



PROTECTIVE GLASSES- 5 11030100

Adjustable length and inclination of temples
Built-in side protectors
Frame made of hypoallergenic material
Protection against high-speed particles 45 m/s - low energy (F)
Reference standards: EN166 EN170

EYE WASHING KITS



EMERGENCY EYE WASHING KIT - CPS258

Recommended to all companies and on transport motor vehicles for emergency eye washing and its subsequent medication. Green case with wall support featuring: 1 empty eye washing bottle 500 ml; 1 eye washing sterile saline solution; wash 500 ml; 2 sterile eye pads; 2 sterile gauze packages 18x40cm; 1 pair of lister scissors 14,5cm; 1 plaster roll 1mx2cm; 1 towelette package; 1 hand mirror; 1 instruction manual.

Dimensions: about 25,5x9x19h cm.

Weight: about 1,2 kg.



EYE WASHING KIT

Eye washing kit featuring 2 disposable and sterile saline solution 500 ml bottles. Rapid eye pad. Thermoformed support with transparent frontal and powder free closing, equipped with small mirror, screws and nogs for wall mounting.

Dimensions: about 32x8x41 cm.

Weight: about 1,8 kg.

CPS202 – EYE WASHING KIT – EYE-SHAPED
TAP003 - EYE WASH CAP WITH ANTI-DUST COVER
SOL002 - PHYSIOLOGICAL SOLUTION 250ML - NOT INJECTION
SOL004 - PHYSIOLOGICAL SOLUTION 500ML - NOT INJECTION

DISINFECTANT PRODUCTS



PHARMA G DISINFECTANT

Disinfectant and detergent based on an association between didecyldimethylammonium chloride and orthophenylphenol. Can be nebulized with ULTRA LITE or in a one-liter bottle with trigger gun (available separately). Pleasant Lemon flavour. Surgical Medical Device.

Q641 - PHARMA G DISINFECTANT 1 LT
Q642 - PHARMA G DISINFECTANT 5 LT



SEPTALDEIDE FOR DISINFECTION AND STERILIZATION

Sterilizing solution containing glutaric surfactant aldehyde, with lemon essence. Efficient against spores and viruses including HIV, LAV, HBV and HCV. Pure application for sterilization of instruments and other objects, including thermolabile ones.

S431 - DISINFECTANT 1 LT



DISINFECTANT IMPREDIS SOFT - CE 19

Cleaning disinfectant for surfaces, surgical instruments, and dental impressions. Based on an association between two quaternary ammonium salts and chlorhexidine. Colorless and slightly orange scented. It does not contain alcohol and is therefore suitable for delicate surfaces and materials not compatible with alcohol. Efficient against HIV and HBV.

DISINFECTANT PRODUCTS



PHARMAIODIO DISINFECTANT

Povidone iodine 1000 ml bottle 10% P.M.C. iodine. Pharmaiodio is bactericide and virucidal and is suitable for pre-injection disinfection, pre-surgical preparation and intact skin antiseptic.

PF08110 - PHARMAIODIO 1 l
PF08111 - PHARMAIODIO 500 ml
PF08173 - PHARMAIODIO 125 ml



HYDROGEN PEROXIDE

1 lt. hydrogen peroxide bottle. Hydrogen peroxide, 3% solution – 10% volume. Stabilized with proper treatment. Suitable for skin cleaning.

MED98508 - HYDROGEN PEROXIDE 250 ml
MED98510 - HYDROGEN PEROXIDE 1 l



NON-INJECTABLE PHYSIOLOGICAL SOLUTION

0.9% non-injectable sodium chloride physiological solution. Sterile and apyrogenic solution in a recyclable polyethylene container. For wounds, suitable in-between and post-surgery. For bladder catheters and oral cavity cleaning. Cleaning and rinsing of surgical instruments and equipment.

195B230541 - PHYSIOLOGICAL SOL. 250 ml
195B230551 - PHYSIOLOGICAL SOLUTION 1 l



PHARMASIL 250 ML - B300

Rapid and persistent disinfectant for non-wounded skin. Mixture of didecyldimethylammonium chloride and orthophenyl. It rapidly gets rid of unwanted pathogenic microorganisms. Efficient against gram+ and gram- acid resistant bacteria. Scented, no burn, no stains. Surgical medical device.

DISINFECTANT PRODUCTS



SEPTAMAN GEL

Surgical Medical Device. Gel colourless alcohol solution (Ethyl alcohol 70%), ready to use, suitable for rapid and effective disinfection of intact skin. Kills bacteria, fungus, micro-bacteria and viruses. Furthermore, inactivates HIV, HBV, HCV and Rotaviruses. Contains no allergenic substances.

PF32459 - SEPTAMAN GEL 100 ml

PF32411 - SEPTAMAN GEL 500 ml

AN0425058 - WALL HOLDER SEPT. 500 ml



MEDICAL SPRAY DISINFECTANT - PF011

150 ml bactericide disinfectant. Bactericide and fungicide action, suitable for environmental disinfection treatments with automatic supply. This system allows the distribution of the product in the environment thus efficiently disinfecting floors, walls, surfaces and air. It allows the complete and rapid disinfection of waiting, emergency, consulting and surgical rooms besides ambulances and classroom. Products diffusion is about 4 minutes long.



DISINFECTANT TOWELETTE - TOW223

Disinfectant towelette: each sachet contains 3 ml of Pharmaderm.

Dimensions of sachet: 65x95 mm circa.

Dimensions of towelette: about 140x190 mm.



4% AMMONIA WIPE - TOW013

Ammonia wipe in water solution 4%.
10 pcs package.

COLD/HOT THERAPY



DISPOSABLE INSTANT ICE PACK - FCT2000

Disposable ice with controlled temperature (0°C for about 30 minutes). Its immediate use during traumas avoids haematoma and swelling formation. It stops little haemorrhages and considerably reduces the pain. It can be kept without limits at ambient temperature.

Made in PVC material. Dimensions 17x13,5 cm. CE medical device.



DISPOSABLE NON-WOVEN ICE PACK - 02SF1853EASYICE

Disposable synthetic ice that keeps 0°C temperature for about 30 minutes.

Does not contain ammonium nitrate.

Made in non-woven material.

Dimensions: 13,5x17 cm.



SPRAY ICE

Spray ice bottle ready to use. Particularly suitable for sport activities, small traumas and contusions. CE medical device.

SP200DISPO24 - SPRAY 200 ml

SP400DISPO24 - SPRAY 400 ml

COLD/HOT THERAPY



HOT/COLD GEL - DISPOGEL

Reusable gelatin hot/cold Dispo GEL
It is a hot/cold reusable accumulator from outside source. Completely non-toxic, suitable for medical and domestic use: easily modeled, does not harden becoming ice and it is reusable. Cold therapy: keep in freezer for at least 2 hours. Take out of the freezer and put in a cloth and apply on the affected part. Hot therapy: place the bag in the microwave for at most 1 minute setting it to 650 Watt or dip the bag in boiling water for at most 5 minutes, remove and dry; in both cases insert the bag in a cloth and apply on the affected part.

Dimensions: about 14x24 cm.



DISPOSABLE INSTANT HOT PACK - 002SC1853HOT

Disposable instantaneous hot pack with a controlled temperature of 60°degrees lasting about 25 minutes.

Dimensions: about 13,5x17 cm.

ISOTHERMIC AND FIREPROOF BLANKETS

ISOTHERMIC BLANKET

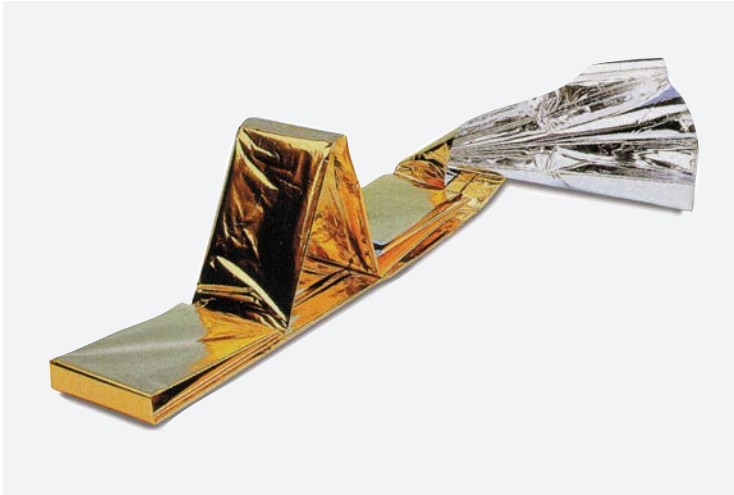

Protection and rescue isothermic blanket
Prevents patients' hypothermia whether traumatized, burned or post-operated
Double function: warming and cooling
Silver side, if positioned toward the body, isolates and reflects, preserving about 80% of body warmth. Thus protects patient from hypothermia, coldness, freezing and shock.
Golden side: placed toward patient body and silver one, reflects sun ray maintaining body freshness. Non sterile.
Adult dimensions: about 160x210 cm.
Pediatric dimensions: about 100x80 cm.

FS-128 - ADULT ISOTHERMIC BLANKET
FCT3010 - PEDIATRIC ISOTHERMIC BLANKET



FIREPROOF BLANKET

Fiberglass, fireproof blanket, EN 1869 compliant. Suitable for extinguishing small fires, especially for small oil fires.
Supplied with a case equipped with a ring for wall mounting and velcro opening.

COP208 - FIREPROOF BLANKET 120x180 cm
COP215 - FIREPROOF BLANKET 150x100 cm

ABSORBING TRANSFER SHEET WRASFER - 610007

TRANSFER SHEET

150 KG AND 3,5 LITERS

Wrasfer sheet in addition to being highly resistant (150 kg maximum carrying weight) allows the absorbency of fluids and exudates up to 3,5 liters, which guarantees the optimum containment of possible infections. Disposable device of the risk class I, made of 3-layer construction: PE-foil, nonwoven and cellulose fluff.

It has been specifically studied for the transfer assistance of patients and it has been designed for use in paramedic services, hospitals, hospital emergency wards, nursing homes, funeral chambers and for remains transportation in special conditions.



EASY TO USE

After its use the sheet can be easily eliminated and the carriers or stretchers are ready for the next use.

Sheet dimensions: 220x100 cm. Weight: 350g.
The application of the transfer sheet should be adequate to provide assistance to two/four patients.



WASTE SACKS AND SHEETS



VOMIT ABSORBING BAG - V60020

Vomit bag “100% Protected Hands.
Fitted with an absorbent pad with Alveol-Technology, it absorbs the vomit and allows its elimination: no dispersion. New MDPE liner: more resistant. Does not stick to the skin. Hypoallergenic.
Dimensions: 25x25 cm.
Packs containing: 20 pcs.
Latex Free, single use only.
CE Medical device.



ROLLED SHEETS - 005 P LU

Sheet rolls in pure cellulose, suitable for examination tables.
Embossed surface, two layers.
Average veil weight:
17 gr/mq.
Pack of 6 pieces.
Colour: white.
Dimensions: 70m x 60 cm.



WHITE VOMIT AND WASTE SACK - SAC052

White waste sack with hermetic closing. It takes little space and can be stored inside emergency bags and rescue rucksacks.
Dimensions: 30x50cm.
100 pieces package.

INSTRUMENTS - SCISSORS



FIRST AID SCISSORS CUT CLOTHING

Stainless steel first aid scissors cut clothing. Autoclavable plastic handle. Suitable for first aid bags and cases. Dimensions: 18 cm.

STR110010 - BLACK SCISSOR
STR110010/A - ORANGE SCISSOR
STR110010/B - BLUE SCISSOR
STR110010/G - YELLOW SCISSOR
STR110010/R - RED SCISSOR
STR110010/V - GREEN SCISSOR



LISTER SCISSORS

First aid cut-clothing stainless steel scissors. Suitable for emergency bags and cases .

STR110291 - LISTER SCISSORS 14 cm
STR110300 - LISTER SCISSORS 16 cm
STR110310 - LISTER SCISSORS 18 cm
STR110320 - LISTER SCISSORS 20 cm



LITTAUER LIGATURE SCISSOR - STR110330

Ligature scissors. Made in stainless steel
Dimensions: 14 cm.

INSTRUMENTS - SCISSORS



FIRST AID SCISSORS - FOR078

First aid scissors with plastic handle.
Stainless steel blades.
Dimensions: 10 cm.



STRAIGHT SCISSORS WITH BLUNT

Straight medication scissors with blunt tips.
Made in stainless steel.

STR110080 - SIZE 14 cm
STR110090 - SIZE 16 cm



STRAIGHT SCISSORS WITH SHARP TIPS

Straight medication scissors with sharp tips.
Made in stainless steel.

STR110040 - SIZE 14 cm
STR110050 - SIZE 16 cm



STRAIGHT SCISSORS WITH ALTERNATE TIPS

Straight medication scissors with alternate tips, blunt/sharp. Made in stainless steel.

STR110060 - SIZE 14 cm
STR110070 - SIZE 16 cm



SCISSORS WITH SHARP TIPS

Medication scissors with bent alternate tips, blunt/sharp. Made in stainless steel.

STR110030 - SIZE 14 cm
STR110032 - SIZE 16 cm



BENT SCISSORS WITH ALTERNATE TIPS

Medication scissors with bent alternate tips, blunt/sharp. Made in stainless steel.

STR110020 - SIZE 14 cm
STR110035 - SIZE 16 cm

INSTRUMENTS - SCISSORS



MULTIPURPOSE EMERGENCY SCISSORS - FOR299

Multipurpose Emergency scissors
Ideal in cases of emergency to break crystals, cut clothes, cut safety belts, cut thick objects (knife function). Made of metal that is not subject to oxidation, without plastic parts. You can open it completely, dividing it into two pieces, to wash it more easily. Completely autoclavable. Supplied with cover and accessories for wall mounting.



ROBIN SCISSORS - 124900

Multi-function emergency scissors, Robin original. Made in Solingen steel. It easily cuts fasten belts. Its handle allows car glasses crush. Supplied with wall support. Weight: 400 g.

124900 - ROBIN SCISSORS

124901 - WALL HOLDER FOR ROBIN SCISSOR



STERILE DISPOSABLE SCALPEL

Disposable sterile scalpel, singularly packaged. Handle in abs material. Stainless steel blade. Blade protection in polythene, easy to remove.

40070 - DISPOSABLE SCALPEL SIZE 10

40071 - DISPOSABLE SCALPEL SIZE 11

40072 - DISPOSABLE SCALPEL SIZE 12

INSTRUMENTS



REMOVAL PENCIL - MAT022

Small metallic splinters eye tool remover. One side you have a NEODIMIO magnetic point, which enable you to withdraw all metallic splinters avoiding any eventual dangerous eye approach. On the other side you have an non-abrasive nylon loop which is used for non metallic splinters. Main body and support made of anodised aluminium and the neoprene seals guaranty a better pencil hold. Supplied in a practical box. CE medical device.



PERCUSSION HAMMER - STR110270

Percussion hammer. Zinc plated handle. Head in pvc. Complete with needle. Dimensions: about 18x6x1,5 cm.



DISPOSABLE TRICHOTOMY RAZOR - RSA225

Trichotomy razor suitable for hairs removal in the area of the skin supposed to surgical operation so to avoid possible infections. Stainless steel blade. Disposable non-sterile single blade.

INSTRUMENTS - FORCEPS



MAGILL FORCEPS

Intubation Magill forceps. Made in autoclavable and disinfestable stainless steel.

STR110230 - MAGILL FORCEPS 16 cm
STR110240 - MAGILL FORCEPS 20 cm
STR110250 - MAGILL FORCEPS 25 cm



CLAMP PLASTIC FORCEPS - STR110450

Clamp plastic forceps.
Dimensions: 12 cm.



SURGICAL AND ANATOMIC TWEEZERS

Anatomic tweezer made in stainless steel.

STR110100 - ANATOMIC TWEEZER THIN 14 cm
STR110110 - ANATOMIC TWEEZER 14 cm
STR110120 - ANATOMIC TWEEZER 16 cm
STR110130 - SURGICAL TWEEZER 14 cm
STR110140 - SURGICAL TWEEZER 16 cm



PEAN, KOCHER AND WIRE CONDUCTOR FORCEPS

Tweezer made in stainless steel.

STR110150 - PEAN FORCEPS 14 cm
STR110160 - PEAN FORCEPS 16 cm
STR110170 - KOCHER FORCEPS 14 cm
STR110180 - KOCHER FORCEPS 16 cm
STR110190 - MATHIEU WIRE CONDUCTOR FORCEPS 14 cm
STR110200 - MATHIEU WIRE CONDUCTOR FORCEPS 16 cm
STR110220 - WIRE CONDUCTOR FORCEPS 14 cm
STR110280 - MOSQUITO FORCEPS

INSTRUMENTS - FORCEPS



RING CUTTER FORCEPS - STR110500

Stainless steel ring cutter forceps.
Dimensions: 18 cm.



NYLON FORCEPS - PIN 103

Nylon forcep singularly packed
Sterile. 8 cm.



STAINLESS STEEL TONGUE FORCEPS - STR110210

Stainless steel tongue forceps.
Dimensions: 17 cm.

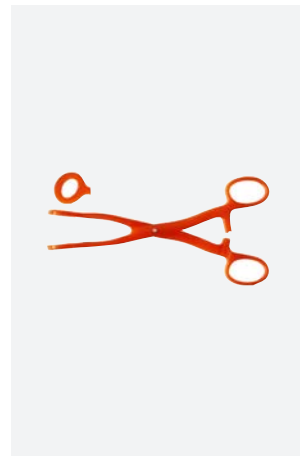

PLASTIC TONGUE FORCEPS - PIN201

Polycarbonate tongue forceps.
Dimensions: 16 cm.



PLASTIC TICK-REMOVING TWEEZERS - STR110462

Suitable for animals. The pen-shaped structure allows to capture the body of the tick in order to extract it with a rotatory movement. The correct extraction prevents infections.
Dimensions: 9 cm.
Colours availability: random.

EMERGENCY KITS



PERIPHERAL VEINS CANNULATION SET - VAL44060

Peripheral veins cannulation set in pouches with transparent frontal, containing:
1 haemostatic belt, 5 canula needles (16/17/18/20/22), 3 butterfly needles (21/23/25), 1 silky plaster roll 2,5 cm, 4 disinfectant wipes, 2 IV administration sets.
Dimensions : about 27x12x9(h) cm



VALVE KIT TYPE HEIMLICH - 220000066910

Non-return valve for thoracic drainage (Heimlich type). Valve body in flexible and transparent polyurethane with natural rubber sleeve in “duck’s bill” shape acting as a non-return valve. This device is connected directly onto the patient’s pleural or thoracic drain (adult, paediatric), or indirectly, using connector code 800.01 and an extension tube for neonates and infants. This product allows thoracic drainage to continue without risk to the patient even when transported, as the non-return valve means that the drain does not have to be clamped.



PLEUROTHORAX SET - 250.200

Closed System comprising: secretion bag 2,0 ltr. with non-return valve, stopcock on the base and three-way stopcock (fixed). Transfusion Tube Luer-Lock (unscrewable). Puncture Cannula Diameter 2 mm; puncture length 75 mm. 50-ml-syringe Luer-Lock. Sterile double wrapped; Peel-Pack.

FIRST AID KITS



TRAVEL KIT - VAL44081

Travel first aid kit complete with: 2 small bags for minor burns treatment, 2 2-pieces non-woven sterile compress, 1 plaster strip, 2 glove pairs in non-sterile package, 3 disinfectant tissues, 1 nylon non sterile tweezers, 1 cohesive elastic bandage, 1 first aid scissors, 2 ammonia towels, 1 suture plasters package, 1 disposable standard instant ice, 40 plasters.

Dimensions: about 15x12x8,5 cm.



MOUNTAIN RESCUE FIRST AID KIT - VAL44082

Mountain rescue first aid kit complete with: 1 emergency isothermal blanket, 2 small bags for minor burns treatment, 5 2-pieces non woven compresses, 1 sterile sheet, 1 bag of aluminized dressing, 1 striped medicated plaster, 2 pairs of non-sterile gloves, 4 disinfecting wipes, 1 small first aid scissors, 1 sterile nylon tweezers, 1 life saver wipe, 2 napkins, ammonia 4%, 1 pack of suture plasters, 1 pack of standard disposable ice, 40 assorted plasters, 1 instant hot compress, 250ml of non-injectable saline solution. Dimensions: about 23x14x11cm.

FIRST AID KITS



DIN 13164 PACKAGE - CPS685

Red nylon handbag. Content complies with what stated by norm DIN 13164 (mandatory on automotive vehicles in certain European Nations). 8 adhesive bandages 10x6cm. Plaster roll 5 m x 2,5 cm. 2 gauze bandages 6 cm x 4 m. 3 gauze bandages 8 cm x 4 m. 1 pair of bandage-cutting scissors. Package of 4 vinyl gloves. Non-woven fabric sheet 60x80 cm. 2 non-woven fabric sterile sheets 60x40 cm. 3 sterile swab bandages 80x100 mm. Sterile swab bandage 100x120 mm. 6 non-woven fabric sterile swabs 10x10 cm. 2 non-woven fabric triangular sheets 96x96x136 cm. Isothermal blanket. Dimensions: 25x15x7,5 cm. Weight: 0,45 kg.



DEFIB SET - MED98950

Ready to use set for early defibrillation, consisting of:

Clothes-cutting scissors

Trichotomy razor

1 pair of disposable gloves

2 disinfectant wipes

2 non-woven absorbing compresses

10x10 cm

Life key ventilation mask

FIRST AID KITS



FIRST AID INDIVIDUAL KIT - VAL44078

Complete first aid and medication kit: Isothermic blanket, 3,5 ml Idrogel sachet, 2 sterile non woven compresses, Sterile medication cloth 60x80 cm, 2 Alumed medication pack size M, Transparent plaster roll 2,5 cm, Cotton medicated plaster 10x6 cm, 2 pairs of gloves in non-sterile package, 2 disinfectant wipes, Small first aid scissors, Nylon sterile tweezers, Life saver, Ammonia 4% wipe, First aid instructions.
Dimensions: about 15x12x8,5 cm.
Weight: about 200 g.



CAR DIN 13164 SET INCREASED - VAL44362

Practical first aid bag for cars: 1 plaster roll, 8 strip plaster, 1 wound medication package L, 3 wound medication packages M, 2 immobilization triangular clothes, 1 sterile medication cloth for burn, 2 sterile medication clothes for burns, 3 big sized medication bandage gauzes, 2 medium sized bandages, 6 sterile gauze compresses, 1 angular medication scissors, 1 emergency isothermic blanket, 4 vinyl protection gloves, 8 disinfectant wipes, 3,5 ml Idrogel burns sachet, 2 4% ammonia wipes for insect stings.
Dimensions: about 27x12x9(h) cm.
Weight : about 0,5 kg.



FIRST AID KIT-MOTORBIKE DIN 13167 - 17008

First Aid Kit for motorbikes with content according to DIN 13167. 1 roll of adhesive plaster, 14-piece adhesive dressing assortment: 4 wound dressings, 2 fingertip dressings, 2 finger bandages, 2 plasters, 4 plasters. 1 first aid dressing, sterile, 1 first aid dressing, sterile, 1 burn dressing, sterile, 1 rescue blanket, 1 bandage scissors, 2 pairs of disposable gloves, 2 wet cleansing wipes for unwounded skin, 1 first aid instructions, 1 list of contents.

REPLANTATION KITS



REPLANTATION SET - VAL40954

Replantation set in a tearproof impermeable equipped bag with 4 coloured pouches with handles transparent frontal, complete of:

- 1 sterile replacement/transport set for finger,
- 1 sterile replacement/transport set for hand,
- 1 sterile replacement/transport sack for arm,
- 1 sterile replacement/transport sack for leg,
- Hemostatic belt/lace, 1 tourniquet type Martin,
- 10 sterile gauze packs 10x10cm,
- 1 plaster roll 2,5cm,
- 1 emergency pad bandage,
- 1 Alumed cloth 40x60cm,
- 1 anatomic forceps,
- 1 surgery forceps,
- 1 Pean forceps.

Dimensions: about 48x16x26(h) cm.

Weight: about 5,5 kg.

MED98820 - HAND REPLANTATION SET - 300x250 mm
MED98824 - ARM REPLANTATION SET - 700x250 mm
MED98828 - LEG REPLANTATION SET - 1100x400 mm
MED98832 - FINGER REPLANTATION SET - 200x200 mm
MED98810 - HAND REPLANTATION BAG - 300x200 mm
MED98811 - FINGER REPLANTATION BAG - 200x200 mm
MED98812 - ARM REPLANTATION BAG - 700x200 mm
MED98813 - LEG REPLANTATION BAG 1100x400 mm
VAL40954 - REPLANTATION SET

REPLANTATION LIMBS SET CASE - VAL40950

Replantation limbs set case, made in shockproof orange ABS, featuring:

- 1 sterile replacement/transport set for finger,
- 1 sterile replacement/transport set for hand,
- 1 sterile replacement/transport sack for arm,
- 1 sterile replacement/transport sack for leg,
- 1 haemostatic lace/belt,
- 10 sterile gauze packs 10x10cm,
- 1 plaster roll 2,5cm,
- 1 emergency pad bandage,
- 1 Alumed cloth 40x60cm,
- 1 anatomic forceps,
- 1 surgery forceps,
- 1 Pean forceps.

Dimensions: about 42x15x31(h) cm.

Weight: about 7,5 kg.



EMERGENCY DELIVERY KITS



EMERGENCY DELIVERY SET - VAL40730

Emergency delivery set in pouch with transparent frontal, featuring: 1 clamp forceps, 2 sterile umbilical forceps, 3 sterile medication bandages, 1 mucus aspirator, 1 baby isothermic blanket, 2 sterile medication clothes 40x60cm, 2 sterile highly absorbing compresses, 5 sterile gauze compresses 10x10cm, 2 elastic bandages, 1 plaster roll, 1 pair of sterile gloves, 1 first aid scissors, 1 bottle of Povidone Iodine.
Dimensions: about 27x12x9h cm.



EMERGENCY DELIVERY SET IN CASE - VAL40732

Emergency birth set in case with transparent frontal, featuring: 1 Clamp forceps, 2 sterile umbilical forceps, 3 sterile medication bandages, 1 mucus aspirator, 1 baby isothermal blanket, 2 sterile medication clothes 40x60cm, 2 sterile highly absorbing compresses, 5 sterile gauze compresses 10x10cm, 2 elastic bandages, 1 plaster roll 1 pair of sterile gloves, 1 scissors 14cm, 1 bottle of Povidone Iodine.
Dimensions: about 25,5x9x19,5(h) cm.

IDROGEL BURN DRESSING

Anti-burn Burnshield provides the necessary skind hydration support, it cools and helps burn depth decrease, erythema and immediate pain reduction. IIb class of risk, clinically tested and suitable on I, II and III degree burns even in case of wounded skin. Suitable for every need and in various sizes and dimensions. Sterile packaging. Non-toxic and excoriate-free. Suitable for pediatric use. Does not stick to the skin, easily removable, elastic and flexible. Biodegradable.



GAUZE

- 901007 - IDROGEL GAUZE 60X40 CM
- 901111 - IDROGEL GAUZE 10X10 CM
- 900906 - IDROGEL GAUZE 20X20 CM
- 901130 - IDROGEL DIGIT GAUZE 2,5X50 CM
- 901131 - IDROGEL BANDAGE ARM/NECK MT 1,5X5 CM
- 901000 - IDROGEL FACIAL GAUZE 20X45 CM



ACTIVE IDROGEL SACHET - 550004

3,5 ml active gel sachet.



IDROGEL BURN PROOF SPRAY - 500520



CONTOUR BLANKET IDROGEL 1X1M - 881006

Idrogel blanket 1x1 m in pure new wool, linked with double knitted fabric, imbued with 900 gm active gel substance.

BURN DRESSING KITS



MINI KIT USTIONI - VAL 40516

Mini burn kit for burns treatment contained in a pouch, featuring:

2 burn dressings. Size: 10x10 cm

1 burn dressing. Size: 20x45 cm

2 specific sachets for minor burns of 3.5 grams each

1 pair of sterile gloves, size M

1 elastic medication bandage

1 emergency scissors with plastic handles

Dimensions: about 23x13x10 cm ca.

Weight: 0.7 kg ca.

All contained devices are CE marked

ITALY MEDICATION CASE D.M. 388/2003 - D.LGS. 81/2008 ANNEX 1



ITALY MEDICATION CASE ANNEX 1

Medication case complete with:
5 pairs of disposable sterile gloves; 1 anti-squirt visor; 1 litre of cutaneous Povidone-iodine with 10% iodine; 1.5 litre of saline solution; 10 packages of sterile gauzes 10 x 10 cm – single packaging; 2 packages of sterile gauzes 18 x 40 cm – single packaging; 2 disposable sterile sheets; 2 disposable sterile medical forceps; 1 medium-sized elastic bandage; 1 package of hydrophilic cotton; 2 packages of various sized plasters ready-to-use; 2 rolls of high plaster 2,5cm; 1 pair scissors; 3 tourniquets; 2 packages of instant ice; 2 disposable sanitary waste bags; 1 thermometer; 1 sphygmomanometer; 1 stethoscope.
Dimensions: about 39,5x13,5x26(h) cm.
Weight: about 5,8 kg.

VAL45180 - MEDICATION CASE D.L. 81/2008 ANN. 1
VAL45184 - MEDICATION CABINET D.L. 81/2008 ANN. 1
VAL45150 - MEDICATION BAG 33 D.L. 81/2008 ANN. 1
MED98878 - MEDICATION PACKAGE D.L.81/2008 ANN. 1 BASE
MED98874 - MEDICATION PACKAGE D.L.81/2008 ANN. 1 COMPLETE



ITALY MEDICATION CASE D.M. 388/2003 - D.LGS. 81/2008 ANNEX 2



ITALY MEDICATION CASE ANNEX 2

Medication case complete with:
2 pairs of disposable sterile gloves; 125 ml of cutaneous Povidone Iodine with 10% iodine; 250 ml of saline solution; 3 packages of sterile gauzes 10 x 10 cm – single packaging; 1 packages of sterile gauzes 18 x 40 cm – single packaging; 1 disposable sterile medical forceps; 1 package of hydrophilic cotton; 1 package of various sized plasters ready-to-use; 1 roll of high plaster 2,5 cm; 1 roll of elastic edged bandage – height 10 cm; 1 pair scissors; 1 tourniquet; 1 package of instant ice; 1 disposable sanitary waste bags;
Dimensions: 25x9x19,5 C cm.
Weight : about 1,3 kg.

VAL45170 - MEDICATION CASE D.L. 81/2008 ANN. 2
VAL45174 - MADICATION POUCHE D.L. 81/2008 ANN. 2
MED98870 - MEDICATION PACKAGE D.L.81/2008 ANN.2



BOLZANO MEDICATION CASE D.P.P. 25/2005 ANNEX 1

BOLZANO MEDICATION CASE ANNEX 1



Medication case complete with:
5 pairs of disposable sterile gloves; 1 anti-squirt visor; 1 litre of cutaneous Povidone Iodine with 10% iodine; 1.5 litre of saline solution; 10 packages of sterile gauzes 10 x 10 cm – single packaging; 2 packages of sterile gauzes 18 x 40 cm – single packaging; 2 disposable sterile sheets; 2 disposable sterile medical forceps; 1 medium-sized elastic bandage; 1 package of hydrophilic cotton; 2 packages of various sized plasters ready-to-use; 2 rolls of high plaster 2,5cm; 1 pair scissors; 3 tourniquets; 2 packages of instant ice; 2 disposable sanitary waste bags; 1 thermometer; 1 sphygmomanometer; 3 medication packages - 8 cm; 3 medication packages - 10 cm; 3 elastic edged bandage - size 8 cm; 3 elastic edged bandage - size 10 cm; 1 isothermic blanket; 1 protection handkerchief for artificial ventilation; 250 ml bottle of disinfectant; 1 stethoscope.
Dimension: about 39,5x13,5x26 cm.
Weight: about 6,2 kg.

VAL45186 - BZ MEDICATION CASE D.L. 81/2008 ANN. 1
VAL45188 - BZ MEDICATION CABINET D.L.81/2008 ANN. 1
VAL45152 - BZ MEDICATION BAG 33 D.L. 81/2008 ANN. 1
MED98868 - BZ MEDICATION PACKAGE D.L.81/2008 BASE ANN. 1
MED98866 - BZ MEDICATION PACKAGE D.L.81/2008 COMPLETE ANN. 1



BOLZANO MEDICATION CASE D.P.P. 25/2005 ANNEX 2



BOLZANO MEDICATION CASE ANNEX 2

Medication case complete with:
2 pairs of disposable sterile gloves; 125 ml of cutaneous Povidone Iodine with 10% iodine; 250 ml of saline solution; 3 packages of sterile gauzes 10 x 10 cm – single packaging; 1 packages of sterile gauzes 18 x 40 cm – single packaging; 1 disposable sterile medical forceps; 1 package of hydrophilic cotton; 1 package of various sized plasters ready-to-use; 1 roll of high plaster 2,5 cm; 1 roll of elastic edged bandage – height 10 cm; 1 pair scissors; 1 tourniquet; 1 package of instant ice; 1 disposable sanitary waste bags; 2 medication packages - 8 cm; 2 medication packages - 10 cm; 2 elastic edged bandage - size 8 cm; 2 elastic edged bandage - size 10 cm; 1 isothermic blanket; 1 protection handkerchief for artificial ventilation.
Dimensions: about 25,5x9x19,5 cm.
Weight: about 1,5 kg.

VAL45176 - BZ MEDICATION CASE D.L. 81/2008 ANN.2
VAL45178 - BZ MEDICATION POUCHE D.L. 81/2008 ANN.2
MED98864 - BZ MEDICATION PACKAGE D.L.81/2008 ANN.2





MEDICAL OXYGEN

OXYGEN THERAPY MASKS



OXYGEN THERAPY MASK- 11914020304 - OS/100

Adult oxygen therapy mask. Manufactured in transparent, atoxic and soft material complete with adjustable elastic. Supplied with 210 cm crushproof tube . Singulary packaged.



PEDIATRIC OXYGEN THERAPY MASK - OS/100P

Pediatric oxygen therapy mask made of transparent, atoxic and soft material complete with adjustable elastic. Supplied with 210 cm crushproof tube. Singulary packaged.



**ADULT OXYGEN THERAPY MASK WITH RESERVOIR
- OS/50**

Oxygen therapy mask with reservoir and non-return valve. Made of transparent, atoxic and soft material complete with adjustable elastic. High concentration (60% Oxygen). Metal nose clip allowing a safe and comfortable appliance. Supplied with 210 cm crushproof tube and universal connector. Size: adult nr. 6.



**PEDIATRIC OXYGEN THERAPY MASK WITH RESERVOIR
- OS/50P**

Oxygen therapy mask with reservoir and non-return valve. Made of transparent, atoxic and soft material complete with adjustable elastic. High concentration (60% Oxygen). Metal nose clip allowing a safe and comfortable appliance. Supplied with 210 cm crushproof tube and universal connector. Singulary packaged.

OXYGEN THERAPY MASKS

ADULT VARIABLE CONCENTRATION MASK- OS/60K

Mask for oxygen therapy with variable concentration. Made of transparent, non-toxic and soft material, complete with adjustable elastic. Metal nose clip for safe and comfortable application. Equipped with a 210 cm anti-crushing hose and an adjustable concentration connection. Size: adults.



OXYGEN THERAPY NASAL CANULA 180CM - 11914020101

Disposable oxygen therapy nasal canula. Manufactured in atoxic and soft material. It allows freedom of movement and do not interfere with feeding and vocal activities. Supplied with a 180 cm tube in singularly sealed package.

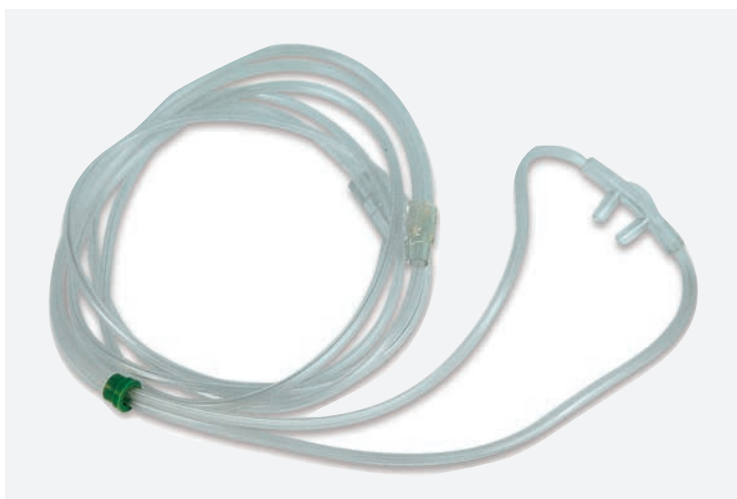

CRUSHPROOF OXYGEN FOR RESUSCITATOR BAGS - 11914020204

Oxygen 2 m crushproof tube extension complete with male/female connectors.



OXYGEN DISTRIBUTION KITS FOR AMBULANCES



Il nostro kit di distribuzione per ossigeno medicale è stato accuratamente progettato e costruito per essere montato nei veicoli per l'emergenza (ambulanze): la modularità del sistema permette di scegliere il numero e il tipo di unità terminali necessarie, l'inserimento o meno del manometro e/o dello scambiatore manuale; a seconda della configurazione (unità terminali, lunghezza tubo e tipo di raccordo) sono disponibili kit con codici specifici. Su richiesta del cliente è disponibile anche una piastrina che consente il fissaggio della barra sotto-parete.

La Oscar Boscarol srl e i suoi centri di assistenza ufficiali sono gli unici autorizzati alla riparazione, manutenzione e ispezione tecnica dei dispositivi Boscarol: contattateci per informazioni.

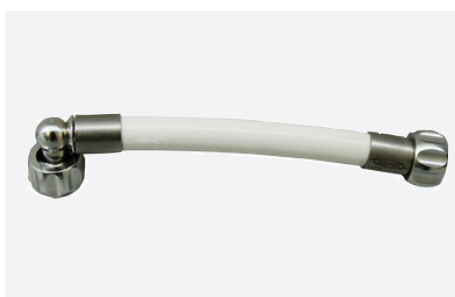
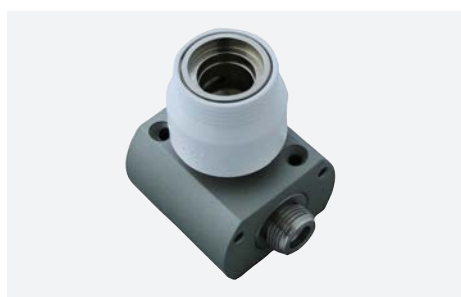

OXYGEN CYLINDER EXCHANGER

EXTERNAL SWITCH



Mechanical manual switcher for oxygen control on oxygen distribution kits with 2 inlets and 1 output. Both available with lateral and back inlets/outlets. It allows 2 low pressure oxygen flow selections (max. 8 bar – 800 kPa). Oxygen compatible, made with properly treated material on surface so to grant full compliance to ISO15001. Class of risk: IIa. Big control knob easy to use also with gloves. 3/8" oxygen hose connector. Optional: frontal plate for wall embedding.

OXIP7000 - EXT SWITCH 2EL-1UL
OXIP7001 - EXT SWITCH 2EP-1UP
OXIP7003 - EXT SWITCH 2EP-1UL
OXIP7004 - EXT SWITCH 2EL-1UP
OXIP7000P - EXT SWITCH 2EL-1UL PLATE
OXIP7001P - EXT SWITCH 2EP-1UP PLATE
OXIP7003P - EXT SWITCH 2EP-1UL PLATE
OXIP7004P - EXT SWITCH 2EL-1UP PLATE

EXTERNAL SWITCH WITH FRONTAL PLATE



High performance mechanical exchanger with lateral or rear inlets/outlets (prepared by the manufacturer). Accommodates the pressure gauge inside the exchange knob for pressures up to 15 bar (1500 kPa). Thanks to the special construction, the pressure gauge is protected against accidental mechanical shocks and impacts. The pressure gauge fitted inside the exchanger allows the size of the oxygen bar to be reduced. 3/8" inlet and outlet connections perfectly compatible with oxygen hoses manufactured by Boscarol. Allows a pressure transducer to be fitted on the outlet for measuring the nominal pressure of the kit. The exchanger includes amounting plate for flush mounting in the ambulance. The plate is made of stainless steel and can be painted according to customer requirements. The Boscarol cylinder exchanger is part of the oxygen kit and should be considered as a spare part

HUMIDIFIER AND FLOWMETER



HUMIDIFIER FOR FLOWMETER INPUT 9/16" - PF-273P-0916

Humidifier for oxygen therapy with 9/16" inlet. Jar and cap autoclavable at 121° C - 2bar - max. 20 minutes. Silicone inner tube with terminal equipped with a filter for homogeneous diffusion of the gas in the water. Hose connector positioned on the humidifier cap for connection to patient-supply-devices (masks, nasal catheters...). Indication of minimum and maximum water filling limits. Latex safe/free. Made in Italy. Class IIa medical device in compliance with 93/42/EEC as amended and UNI 11341 standard.



HOSE CONNECTOR FOR FLOWMETER UNI 9/16" - PF-2630-9600

Hose connector 9/16"
Can replace oxygen humidifier (connected to the flowmeter) allowing connection of masks and other ventilation devices
Single packaging.



FLOWMETER 0-15 LPM

OXI0566 - FLOWMETER 0-15 LPM UNI
OXI0567 - FLOWMETER 0-15 LPM AFNOR
OXI0568 - FLOWMETER 0-15 LPM DIN

PRESSURE REDUCER



PRESSURE REDUCER P300 UNI - 4501051

Pressure reducer for medical oxygen compliant with the standard ISO 10524-1
Made of surface treated brass
P1 (maximum inlet pressure): 300 bar
P2 (nominal output pressure): 4,5 bar
Reducer capacity at 200 bar (20.000 kPa): max. 250 lpm (litres per minute)
Oxygen cylinder connection type UNI 4406
Output connection: 3/8" (three eighths of an inch)
Compliance: CE marking according to MDD 93/42/CEE
Oxygen compatible according to ISO 15001
Operating temperature: -20÷60 °C
Storage and conservation temperature: -20÷60 °C
Warranty: 2 years from date of purchase (see warranty conditions)
Periodic safety check: 5 years from the date of manufacture
Dimensions: about 110x51x58mm
Weight: about 580g





MEDICATION SYMBOL - STE 141510

Adhesive reflex symbol.
Dimensions: 4x4 cm.



INSTRUMENTS SYMBOL - STE 141512

Adhesive reflex symbol.
Dimensions: 4x4 cm.



SUCTION UNIT SYMB. - STE 141514

Adhesive reflex symbol.
Dimensions: 4x4 cm.



OXYGEN BOTTLE SYMB. - STE 141516

Adhesive reflex symbol.
Dimensions: 4x4 cm.



LARYNGOSC. SYMBOL - STE 141518

Adhesive reflex symbol.
Dimensions: 4x4 cm.



RESUSCITAT. SYMBOL - STE 141520

Adhesive reflex symbol.
Dimensions: 4x4 cm.



PHIALS SYMBOL - STE 141522

Adhesive reflex symbol.
Dimensions: 4x4 cm.



INFUSIONS SYMBOL - STE 141524

Adhesive reflex symbol.
Dimensions: 4x4 cm.



GLOVES SYMBOL - STE 141526

Adhesive reflex symbol.
Dimensions: 4x4 cm.



DIAGNOSTIC SYMBOL - STE 141528

Adhesive reflex symbol.
Dimensions: 4x4 cm.



INTERNATIONAL SYMBOLS - STE 141500

Adhesive reflex international
symbolisms. 12 different pieces
packages. Dimensions: 4x4 cm.

OTHERS



PERFECTO PE SHOE COVER 100 PCS - CCPE1200PER

Blue disposable shoe cover in PE (polyethylene), available in one-size, with ankle elastic. Thin, lightweight and waterproof. Ideal for both patients and operators. Medical Device Class I according to European Directive 93/42/EEC and following amendments.

Storage: room temperature in a dry place, away from heat sources, flames, or sparks.

Packaging: box of 100 pcs.



TRIAGE TAGS - PC190000

Triage cards made of cardboard. The triage card is composed not only from the standard part reporting the state and the practiced therapy but also by 4 stubs, perforated tear-off, with 4 different colors, indicating the severity of the patient. Package of 25 pieces
Dimensions: 10,5x20,5 cm.



SAFETY SIGN OF FIRST AID - ACC170550

Safety Sign of First Aid (white cross on a green background).

Made of aluminum.

Dimensions: 25x25 cm.



SAFETY SIGN OF AED - ACC170551

Safety Sign AED.

Made of aluminum.

Dimensions: 25x25 cm.

TORCHES



SNAPLIGHT LIGHTSTICK - ACC170044

Bright torch 15 cm long. Ideal emergency light for every occasion. Different usages in the night and in total darkness. Available in brilliant red light. 12 hours duration.



TORCH "SMALL TRAFFIC BATON" 18 LED RED - ACC170113

Fluorescent LED electronic signal torch. Superior to whatever conventional torch concerning high quality and 400 hours autonomy. Waterproof and very resistant to impacts. A magnetic base allowing fixing on metallic surfaces.

Batteries required: 3x1,5 V (not included)

Dimensions: about 28x4 cm

Weight: about 200 gram



TORCH "TRAFFIC LED BATON" 12 LED

Electronic warning torch with blinking light in red or yellow LED. More than any conventional torch for high quality and for the autonomy of 400 hours. Waterproof and very resistant to impacts. Dimensions: about 4x54 cm.

ACC170111 - YELLOW LED

ACC170117 - RED LED



OSCAR BOSCAROL SRL

Via Enzo Ferrari 29, 39100 Bolzano - ITALY

VAT NUMBER: 01458460217

PH. +39 0471932893

FAX +39 0257760140

@ info@boscarol.it

@ info@pec.boscarol.it

WWW. boscarol.it

f OscarBoscarolSrl

in oscar-boscarol-srl

WORKING SCHEDULE

Monday - Tuesday

09:00-12:30 and 14:00-17:30

Friday: 09:00-13:00

SELLING CONDITIONS

Selling conditions

1. OVERALL

General selling conditions listed hereupon are to be considered valid for every purchasing made to our company Oscar Boscarol S.r.l. and make a fundamental requirement for every purchase order. Possible variations to such clauses rather than particular conditions must be explicitly agreed in written form.

2. ORDERS

Purchase orders are to be sent to the following: fax 0039 0257760140; email info@boscarol.it or on-line via our web site www.boscarol.it (against registration). All orders received will be processed by our commercial department and must be approved by the Oscar Boscarol S.r.l. through a regular order confirmation. Orders will have to be compliant to the packaging details stated on the price list.

3. TRANSPORT

Transport occurs to the customer's account with the amount stated on the invoice or as assigned port (the customer arrange the shipment with his own forwarder). The customer has to check the packaging status at the moment of delivery: should any anomaly be noticed the goods should be accepted with note to the forwarder itself and to the Oscar Boscarol S.r.l.

4. DELIVERY

Delivery terms are stated on our order confirmations and might be subject to variations which are communicated to the customer. Order processing is strictly subject to its written confirmation from the customer.

5. PRICES

Price listed hereupon are to be considered in Euro, VAT and tax excluded. OSCAR BOSCAROL S.r.l. owns the right to perform changes on the prices in case raw materials and/or components price increase occurred.

6. RETURN POLICY AND COMPLAIN

Possible complains must be sent in written form to Oscar Boscarol S.r.l. within 8 days from goods delivery. The return of the goods must be previously authorized by Oscar Boscarol S.r.l.

The authorized returning goods must be addressed to the Oscar Boscarol S.r.l. warehouse at the conditions stated on the return authorization and needs to be shipped together with a transport document stating the reasons of the return together with purchasing references. Return goods will be replaced and/or credited after check-in inspection.

7. SIZE AND DRAWINGS

Indications related to dimensions and drawings on each publication issued by Oscar Boscarol srl have a mere informative purpose and can be modified without notice.

8. PRODUCTS STOCK AVAILABILITY:

All the products marked with (*) are to be intended as AVAILABLE UNTIL STOCK AVAILABILITY.

9. PAYMENT

Payment must be performed in due course and for the amount agreed. Failing to do so might result in the temporarily suspension of supplies and start bank interests appliance.

10. Refer to Bolzano forum for every controversy that might occur.

Please be advised that all the information featured in this catalogue are merely indicative and subject to continuous changes. For any updated information please take a look at our website www.boscarol.it or contact our commercial department.

Oscar Boscarol company reserves the right to update what stated in the technical and advertising files without any prior notice. Please contact our offices via telephone +39 0471 932893 or via email to double check such information.



OSCAR BOSCAROL SRL
Via Enzo Ferrari 29, 39100 Bolzano ITALY - Ph. +39 0471932893 - Fax +39 0257760140
info@boscarol.it - www.boscarol.it

2024/03-EN